

FAO BOBP LIBRARY

BOBP/107/13

Acc No. 817 25/3

Marine Small-Scale Fisheries of India: A General Description



Bay of Bengal Programme



**MARINE SMALL-SCALE
FISHERIES OF INDIA:
A GENERAL DESCRIPTION**

Executing Agency :

**Food and Agriculture Organisation
of the United Nations**

Funding Agency :

**Swedish International
Development Authority**

PREFACE

This document attempts a brief and factual presentation of data and baseline information on the main features of the small-scale marine fisheries of India.

It could serve as an introduction to the problems and prospects of this sector leading to deeper studies of particular aspects; as a source of general information about the sector; or, more particularly, as a background document for use in discussions on the planning and programming of development assistance.

This is a revised and updated edition of a General Description of Small-Scale Fisheries, India, originally prepared in 1976 by the Fisheries Division of the Department of Agriculture, Ministry of Agriculture and Irrigation, New Delhi, India in consultation with the FAO/UNDP Project for Development of Small-Scale Fisheries in Southwest Asia, RAS/74/031, revised in consultation with the Project by Dr. P. V. Rao, Scientist, Central Marine Fisheries Research Institute, Cochin in 1976 and published as RAS/74/031 Working Paper No. 2. The present revision was carried out with the assistance of a national consultant, Dr. T. A. Mammen, formerly Joint Commissioner (Fisheries) to the Government of India.

The preparation of this document is an activity of the Bay of Bengal Programme for Small-Scale Fisheries Development, GCP/RAS/040/SWE, a regional FAO programme funded by the Swedish International Development Authority (SIDA) and executed by the Food and Agriculture Organisation of the United Nations (FAO). Five countries are members- Bangladesh, India, Malaysia, Sri Lanka and Thailand. The aims of the BOBP are to develop, demonstrate and promote appropriate technologies and methodologies to improve the conditions of small-scale fisherfolk and to increase the supply of fish from the small-scale sector in the member countries.

The document is a working paper and has not been officially cleared by the Government or by the FAO.

CONTENTS

| | <i>Page</i> |
|--|-------------|
| 1. Introduction | 1 |
| 2. Fishery resources | 2 |
| 3. Fishing fleet | 5 |
| 4. Infrastructure and service facilities | 6 |
| 5. Production | 7 |
| 6. Handling and processing | 7 |
| 7. Distribution and marketing | 8 |
| 8. Export and import | 10 |
| 9. Coastal aquaculture | 11 |
| 10. Socio-economics | 13 |
| 11. Fisheries administration and institutions | 15 |
| 11.1 Fisheries administration | 15 |
| 11.2 Institutes | 16 |
| 11.2.1 Research and development institutes | 16 |
| 11.2.2 Training institutes | 21 |
| 11.2.3 Others | 23 |
| 12. Industry organisations | 23 |
| 12.1 Fisheries corporations | 23 |
| 12.2 Fisheries cooperatives | 24 |
| 13. Government policy | 26 |
| 14. Development plans | 28 |
| 15. Bibliography | 29 |
| <i>Tables</i> | |
| 7.1 Wholesale prices of fish (Rs./quintal) in some important market centres | 9 |
| 8.1 Exports of Indian marine products | 10 |
| 8.2 Import of fish into India | 10 |
| 9.1 Areas for brackishwater fish culture | 12 |
| 10.1 Employment of fisher-folk (1979) | 13 |
| 10.2 Boat ownership patterns in different maritime states | 14 |
| 10.3 Income of fishermen operating country craft and mechanised boats | 15 |
| 11.2.1.5.1 Training facilities and courses conducted by IFP | 19 |
| 11.2.2.2.1 Duration and intake of training courses for marine fisheries operatives at CIFNET | 22 |
| 12.2.1 Situation of primary fisheries cooperative societies 1977/78 | 25 |
| 12.2.2 Performance of primary fisheries cooperatives in the maritime states 1976/77 | 25 |

| <i>Appendices</i> | <i>Page</i> |
|--|-------------|
| 1.1 Map of India | 31 |
| 1.2 Country data | 32 |
| 3.1 Statewise distribution of mechanised boats (1980) | 36 |
| 3.2 Statewise distribution of non-mechanised marine fishing craft in India (1980) | 37 |
| 3.3 Salient features of some important fishing craft types | 38 |
| 3.4 Statewise figures of marine fishing gears in India 1980 | 39 |
| 3.5 Common craft-gear combinations | 40 |
| 4.1 Fishing harbours at major ports under construction/completed (1981) | 41 |
| 4.2 Fishing harbours at minor ports under construction/completed (1981) | 41 |
| 4.3 Planwise outlays and expenditure for fishing harbours at major and minor ports | 43 |
| 4.4 Development of refrigeration facilities for storage and distribution — planwise | 44 |
| 4.5 Statewise distribution of refrigeration facilities 1980 | 44 |
| 4.6 Manufacture of marine diesel engines | 45 |
| 5.1 Marine fish production in India | 46 |
| 5.2 Percentage composition of marine fish catch by the traditional and mechanised sectors | 47 |
| 5.3 Marine fish production by the traditional and mechanised sectors in the maritime states | 48 |
| 5.4 Trends in fish production by the traditional sector in the maritime states during 1969-77 | 49 |
| 5.5 Trends in fish production by the mechanised sector in the maritime states during 1969-77 | 50 |
| 5.6 Composition of marine fish landings in India during 1977 to 1980 | 51 |
| 5.7 Estimated statewise and species-wise marine fish landings in India during 1980 (in tonnes) | 51 -A |
| 6.1 Statewise capacities for fish canning and fish meal manufacture | 52 |
| 8.1 Structure of exports of marine products from India yearwise by broad categories (1977/78 to 1979/80) | 53 |
| 8.2 Percentage composition of marine products exported from India (1978/79-1979/80) | 53 |
| 9.1 Selected data on production rates in brackishwater fish/prawn culture | 54 |
| 10.1 Statewise figures of marine fishing villages and fisherfolk population in India 1980 | 55 |
| 11.1 Organisational set-up of the fisheries administration in the Government of India | 56 |
| 11.2 Nodal organizations and the specialised institutes under their administrative control | 57 |
| 12.1 Subsidies provided by different states in the fisheries sector | 58 |
| 14.1 Outlays and expenditure for fishery development during the plan periods | 59 |
| 14.2 Central sector and centrally sponsored schemes — outlays in the sixth five-year plan (1980-85) | 60 |
| 14.3 Statewise outlays for fisheries during sixth plan | 61 |
| 14.4 State plan outlay for fisheries development by broad heads of development | 62 |
| 14.5 List of aid projects | 63 |
| Publications of the Bay of Bengal Programme | 65 |

1. INTRODUCTION

India is situated between latitudes 8° 4' and 37° 6' north and longitudes 68° 7' and 97° 25' east. It is bounded in the north by China, Nepal and Bhutan; in the east by Burma and Bangladesh; and in the north-west by Afghanistan and Pakistan. South of the Tropic of Cancer the country tapers off into the Indian Ocean between the Arabian Sea on the west and Bay of Bengal on the east. The Gulf of Mannar and the Palk Strait separate India from Sri Lanka. The Andaman and Nicobar Islands in the Bay of Bengal and Lakshadweep Islands in the Arabian Sea are parts of the territory of India. A map is given in Appendix 1.1.

The maritime States and Union Territories (UT) are as follows:

| <i>West Coast</i> | <i>East Coast</i> |
|--------------------------|----------------------------------|
| Gujarat | West Bengal |
| Maharashtra | Orissa |
| Goa, Daman and Diu (UT) | Tamil Nadu |
| Karnataka | Pondicherry (UT) |
| Lakshadweep Islands (UT) | Andaman and Nicobar Islands (UT) |
| Kerala | |

The present total marine fish production is about 1 million tonnes. In 1980-81 India's total export of fish and fish products was valued at Rs. 2,348 million, which represented about 3.4% of the total foreign exchange earnings of the country. The fisherfolk population of the country is estimated at 5.38 million, representing about 0.8% of the total population of India. Fishing provides direct employment to about 1.8 million fishermen, 0.9 million being engaged in fishing, fish seed collection, etc., and the rest in net-making, fish curing, marketing, etc. Fishermen also often carry on other vocations such as ferrying, salt-making, etc.

The small-scale fisheries sector plays a significant role in Indian fisheries. It contributes about 62% of the country's fish production and about 0.5% of food supplies.

The inland fishermen live in isolated hamlets distributed over a vast geographical area, practically without communication and infrastructural facilities. Quite a number of them are nomads. Compared to this, the marine fishermen are a more compact group of 1.44 million, living in 1,913 villages. Both inland and marine fishermen belong to economically and socially backward communities characterised by large families, low levels of income and literacy and a high degree of indebtedness and a conservative approach to life and vocation.

The problems of small-scale fishermen received little attention prior to independence. The post-independence developmental effort too has been directed largely towards areas like establishment of research institutes, provision of training and infrastructure for mechanised fishing and deep-sea fishing, establishment of ice-making and refrigeration plants and improvement of domestic and export marketing. The benefits of modernisation have been garnered by a minority of energetic fishermen and non-fishermen who could assimilate modern technology, while the majority of fishermen, though marginally benefited by use of synthetic nets, higher market demand for fish and fishery products, etc., have remained virtually unaffected.

Prior to 1944, fisheries was a 'transferred' subject. The administration and management of fisheries were the direct responsibility of the erstwhile provinces. Although the Government of India enacted the Indian Fisheries Act in 1897, it was mostly for empowering the provincial governments to frame rules under the Act. The provincial governments concerned themselves mainly with administering the Fisheries Act and issuing licences for fishing or leasing out Government-owned water areas for fishing. Studies on fishes and other aquatic fauna were carried out mainly by the Marine Survey of India, Zoological Society of India and some universities.

The constitution of a Fish Sub-Committee of the Policy Committee on Agriculture, Forestry and Fisheries in 1944 to review the position of fisheries of the country and to report on the measures necessary for its improvement and development marks the recognition of the need for the development of fisheries by the Government of India. The recommendations of that Committee paved the way for the formulation of various programmes for fisheries development.

After independence, fisheries development was given enhanced importance particularly in the National Plan Schemes (Five-Year Plans), the first of which started from 1951, and significant progress was achieved in different sectors of the fisheries. An organised industry was gradually established. The discovery of rich fishing grounds close to the shore ; improvement of traditional coastal fishing by fishermen; introduction of modern fishing technology; mechanisation of fishing craft and introduction of mechanised fishing boats; establishment of processing, landing and other infrastructural facilities; improvement in distribution and marketing and an ever-increasing demand for fish and fishery products in the internal as well as external markets were factors that contributed to the progressive development of the marine fisheries.

During the first five Five-Year Plans and intervening three annual plan years (1951-79), the main emphasis in marine fisheries development was on the introduction of mechanised fishing boats and mechanisation of fishing craft. At the commencement of the first Five-Year Plan period, there were only 13 mechanised boats in operation. The number went up to 863, 2161, 5206, 7708, 10,576, at the end of the first, second, third plan periods, the 3 annual plan years and the fourth plan periods respectively and stood at about 19,000 at the end of the fifth plan period. Besides this, emphasis was also given to popularisation of synthetic fishing twine and assistance to small fishermen in the form of supply of fishing requisites, salt for fish curing, etc. A large number of ice plants and cold storages were established by the public and private sectors during this period. This development, along with the increasing demand for shrimp in the international market, stimulated the private sector to establish facilities for freezing and canning and it also led to an export trade. Institutes for the training of fisheries personnel of various categories to meet the technical and operative manpower requirements of the fishing industry were established. Fishery survey and research programmes were intensified. The construction of fishing harbours at major and minor ports and provision of landing facilities at various sites were taken up. In order to improve the socio-economic conditions of fishermen and marketing, establishment of fisheries cooperative societies and fisheries corporations was encouraged.

Marine fish production increased from 0.534 million tonnes in 1951 to 1.388 million tonnes in 1979, the base year for the current Sixth Five-Year Plan. Exports of marine products rose from 22,200 tonnes valued at Rs. 33 million in 1951/52 to 86,400 tonnes valued at Rs. 2,488 million in 1979/80.

2. FISHERY RESOURCES

India's climate presents many variations and contrasts. In the north-west, the Rajasthan desert has an average annual rainfall of less than 127 mm, while in the north-east, Chirapunji in Assam records an average rainfall of over 11,000 mm. Temperatures as low as -9.5°C in Kashmir and as high as 49.5°C at Jodhpur have been recorded. The mean annual range of temperature of 66°C at the southern tip of India is less than the daily range at many places in north India.

It may be broadly described as a tropical monsoonal climate. There are four seasons : the winter season (January-February) ; the warm season, summer (March-May) ; the rainy season, south-west monsoon (June-September) ; and the post-monsoon season, which is the north-east monsoon period in the southern peninsula (October-December).

The continental shelf area between 0 and 50 m depth is estimated at $1,94,972\text{ km}^2$ and between 0 and 200 m depth at $452,060\text{ km}^2$. The average width of the shelf from the shore-base varies from 32 km off the coast of Andhra Pradesh to 174.6 km off the coast of Maharashtra. Off Gujarat and Kerala, it is about 65 km while off Goa and Karnataka it is over 90 km.

The fishing grounds in the north-west coast of India are extensive, the sea-bottom being generally muddy and suitable for trawling; in the south-west coast too, the sea-bottom in the inshore

fishing grounds is muddy and productive grounds for shrimp lie within this region. The sea-bottom on the south-east coast is characterised by coral or rocky ground interspersed with even ground. On the north-east coast, the sea-bottom is predominantly muddy in the depth range of 25-100 m and suitable for bottom trawling. In general, between 100-140 metres depth and in some cases even beyond, the bottom is uneven, making bottom trawling difficult.

In recent years, several investigations have been conducted on the physical, chemical and biological oceanography of the seas around India. Several layers of water masses such as the Indian Ocean Central Water, the Indian Ocean Equatorial Water, and the Deep Water at a depth of 2000 metres are recognisable in the region of sub-tropical convergence at about 40°S latitude in the Indian Ocean below the surface waters. There are also the Antarctic Intermediate Water and the Red Sea Water. The movement of the cold Antarctic Bottom Water (Deep Water) from the polar regions into the Arabian Sea and the Bay of Bengal has a bearing on the organic productivity in the region. The Red Sea Water penetrates to great depths across the equator and meets the Antarctic Bottom Water.

The surface temperature along the Indian coast varies from 23°C to 29°C. A comparatively lower temperature reaching a value of 21°C occurs in November-December on the north-western coast of India. In the Bay of Bengal, the usual range of surface temperature is between 27°C and 29°C.

On the west coast of India, the thermocline fluctuates a great deal showing a definite seasonal trend, being found at 100-125 m during winter, at 75-90 m between the monsoons and 20-30 m with the progress of the south-west monsoon. In the Bay of Bengal, the thermocline level is usually below 50-55 m and at times goes down to 100-125 m. The shelf waters in general are mostly isothermal or nearly isothermal. Large-scale upwelling occurs during the south-west monsoon off the west coast. During the north-east monsoon fairly strong convergences develop on the east coast of India and the Andaman Sea.

The average salinity range in the Arabian Sea is between 34‰ & 37‰ and between 30‰ and 34‰ in the Bay of Bengal. The higher salinity of the waters of the Arabian Sea is mainly due to high saline water flowing from the Red Sea and the Persian Gulf. The low salinity of the Bay of Bengal is due to the influence of large river systems emptying into it. Investigations have shown that the waters of the Arabian Sea are somewhat deficient in oxygen at a depth of 200-500 m. This oxygen-deficient water is subject to movement as a result of upwellings.

Various techniques have been employed to estimate the productivity of Indian waters. These include exploratory fishing surveys by the Exploratory Fisheries Project (EFP), the Integrated Fisheries Project (IFP) and the Central Institute for Fisheries Nautical and Engineering Training (CIFNET); acoustic surveys by the former Pelagic Fisheries Project; studies of the oceanography, primary production, chlorophyll, a particulate organic carbon, phaeophytin, etc., by the Central Marine Fisheries Research Institute (CMFRI), the National Institute of Oceanography (NIO) and various universities. CMFRI scientists have estimated the rate of primary production on the east coast at 0.63 gC/m²/day on the shelf and 0.19 gC/m²/day outside the shelf; the mean value within 50 metres depth on the west coast as 1.24 gC/m³/day, the daily rate of production for the rest of the west coast shelf as 0.47 gC/m³/day and for the oligotrophic regions outside the shelf as 0.19 gC/m²/day. The more recent work of NIO seems to indicate that these estimates are low for the east coast and high for the west coast, although strict comparisons are not possible due to differences in analytical methods, variability in time and heterogeneity in space.

The role of oceanographic parameters in relation to the occurrence and migration of fish is relatively better understood for the south-west coast of India. Along the south-west coast, upwelling recurs annually. Meteorological and other oceanographic parameters which influence the fishery also exhibit wide variations in space and time. The most important aspect of the oceanographic features of the area is the prevailing current system at the surface levels which changes direction from one season to another. The southerly current which develops in May continues till November when it reverses and the northerly current continues till April. The southerly current brings comparatively high saline Arabian Sea water southward and the northerly current carries the less saline equatorial waters northward. The spreading effect of the high saline Arabian sea water towards the south is largely neutralised by south-west monsoon rain and river run-off.

Thus, the annual salinity cycle at the surface levels is dependent on the onset of the south-west monsoon and the direction, velocity and duration of the two current systems. The sea-water temperature shows wide seasonal and spatial fluctuations. In areas where upwelled water reaches the surface, the temperature falls considerably below that which could be otherwise expected for the season. The shelf waters are well aerated during most of the year except for the south-west monsoon and the associated upwelling. In August, the oxycline becomes very shallow and in areas of intense upwelling, the low intermediate waters reach the surface and remain there until October especially in areas where upwelling is intense. By December, the shelf waters are once again well aerated. The immediate effect of upwelled water reaching the surface, which is highly oxygen-deficient, is the expulsion of all animals including fish from the vicinity. Dissolved oxygen concentration in these waters slowly increases due to dissolution of atmospheric oxygen. Increased phytoplankton production leading to a zooplankton bloom commences in areas where highly productive water from the bottom levels is brought to the surface. The oil sardine and mackerel fisheries commence immediately after the south-west monsoon, when the zooplankton biomass at the surface layers reaches a peak. A study of the behavioural pattern of the oil sardine, mackerel and white bait and the environmental parameters indicates that the temperature of the sea water and dissolved oxygen at the surface levels influences the seasonal migration of these species which avoid areas of intense upwelling activity mainly because of low oxygen concentration and low temperature conditions.

The 'Muraena' survey has broadly indicated the greater biological production connected with exchange of water masses in the frontal zone between coastal and deeper Arabian Sea. This survey and surveys by vessels of the Exploratory Fisheries Project and Pelagic Fisheries Project have shown the presence of large stocks of horse-mackerel, ribbon fish, etc., in the outer shelf area. Surveys conducted by Dr. FRIDTJOF NANSEN outside Indian waters seem to indicate large resources of mesopelagic species.

In the Bay of Bengal, the surface currents vary from south-westerly to southerly in the north-western part of the bay. A clockwise gyre is present in the north central portion. Off the river Godavari the flow is northwards. South of the Godavari, the flow is complicated with several eddies and a clockwise circulation. These eddies in turn lead to sinking and upwelling which result in alternation of lower and higher production. Because of the lower salinity at the top, the sub-surface water may not reach the surface. A factor however that helps the admixture of the sub-surface nutrient-rich water with the surface layer is the intense cyclonic activity during the post-southwest monsoon period.

The fishing season for the country as a whole is the period October - December. For Maharashtra and Gujarat, the period July-September and for Kerala and Karnataka the period April - June are relatively poor seasons. On the east coast, the peak seasons are October - December for West Bengal and Orissa and January - March for Tamil Nadu and Andhra Pradesh.

Estimates of 10 to 20 million tonnes of potential fish resource for the Indian Ocean have been given by various authors on the basis of relative productivity of the waters and exploratory surveys. For the seas around India, the potential annual fish production in the continental shelf (0-200 m depth) has been estimated at between 2.3 and 4 million tonnes.

Studies conducted by the Exploratory Fisheries Project (EFP) on demersal fishery resources indicated that the most extensive trawling grounds are on the north-west coast of India bordering the Gujarat and Maharashtra coasts up to 75 m depth. Along the east coast, the better trawling grounds in which prawns form an important component of the catch are off the Orissa and West Bengal coasts. On the south-west coast, fishing grounds for prawns are off Maharashtra and Cochin; for elasmobranchs, off Cape Comorin, Cochin, Cannanore and Mangalore; for Lactarius, off Mangalore; for *Nemipferus japonicus*, off Cape Comorin, Cochin and Cannanore; for ribbon fish, off Cochin and Cannanore; and for catfish and 'Kalava', off Cochin.

Less information is available on pelagic fishery resources except for the south-west coast. As a result of the investigations conducted by the Pelagic Fisheries Project, the magnitude of pelagic fishery resources off the south-west coast were assessed at 400,000 tonnes of oil sardine, 300,000 tonnes of mackerel, 400,000 tonnes of white bait, 150,000 tonnes each of horse mackerel

and catfish, besides significant quantities of silver bellies, golden scad, butter fish, etc. Oil sardine, mackerel, white bait and horse mackerel were found to have protracted spawning periods with no definitely demarcated spawning grounds. Oil sardine was found to breed closer to the shore than mackerel.

Recent work by the Exploratory Fisheries Project has given an indication of the presence of large stocks of horse mackerel and ribbon fish along the north-eastern shelf area and of mackerel along the east coast. No quantitative estimates or biological studies however have been undertaken in these areas.

India's fishing effort has been generally increasing. However, the catch and catch per unit of effort indicate fluctuations, mainly due to large-scale fluctuations in ^{major} pelagic fisheries like mackerel and oil sardine. The catch per unit of effort for the country as a whole is not more than 5 kg per man-hour.

3. FISHING FLEET

3.1 Fishing craft

It is estimated that there are about 19,000 mechanised marine fishing crafts in India. The statewise distribution of these craft is given in Appendix 3.1.

The majority of marine fishing craft are non-mechanised. Complete figures of these craft are not available. Appendix 3.2 gives the statewise figures for these craft under four categories with the exception of the figures for Maharashtra. The figures also refer only to craft owned/shared by fishermen. Salient features of some types of fishing craft in India are given in Appendix 3.3.

Fishing gears

A wide variety of fishing gears is used in India. These include drift/gillnets, traps, lines, fixed bagnets, boat seines, shore seines and trawls. The statewise distribution of fishing gears is shown in Appendix 3.4. These figures do not include Maharashtra and refer only to gear owned/shared by fishermen. The main craft-gear combinations are indicated in Appendix 3.5.

The operational pattern of some of the main fishing gears is as follows : Two main types of shore seines and inshore drag nets are employed. The first type consists of a bag and two wings. These are operated along the Orissa, Andhra Pradesh and Tamil Nadu coasts. The other type is the "Rampan" net operated along the Goa, southern Maharashtra, Karnataka and Malabar coasts. The method of operation of both types is that one extremity of the net remains on the shore, while the rest of the net is carried out to sea in a boat, paid out in a semi-circular path and the other extremity brought to another point on the shore. The two ends are then slowly dragged by two parties of men.

Fixed nets are generally rectangular in shape, but vary in size from place to place. They are fixed in the inshore tidal region with stakes or by use of floats and sinkers during low tide periods. The fish coming in with the tide are trapped in the net when the tide recedes.

Bagnets and boat seines are generally conical nets with or without wings. Two catamarans or canoes operate the net when the fishes are trapped in the bag portion. The *do/* net is a bagnet fixed in the sea by stakes or buoys and is operated in Maharashtra and Gujarat waters.

Gillnets and drift-nets are operated by paying out the net from a boat in the fishing ground with one end of the net secured to the boat. The boat and the net are then allowed to drift with the current and the tide. Fish are gilled or entangled in the net.

Cast nets are operated by throwing the net fully spread over a collection/shoal of fish which get trapped within the circumference of the net as it closes due to the weights attached.

Bottom trawling was introduced into India as a commercial gear around 1950. There are several modes of trawl net operation with varying arrangements to keep the mouth open, but the most common method employed is stern trawling with a pair of otter boards. The principle in all

methods is to drag a bag-type net along the sea-floor with two warps of wire-ropes paid out from a winch worked generally by the main engine of the vessel. Many small trawlers, however, operate without winches, using coir or cotton towing ropes and hauling the trawl-net manually.

4. INFRASTRUCTURE AND SERVICE FACILITIES

There are about 1,300 fish landing centres scattered along the Indian coastline. Most centres are open beaches, where basic facilities for landing and disposal of the catch are not available.

The need for providing landing and berthing facilities for fishing vessels was appreciated early in the planning for fisheries development and during the second Five-Year Plan, assistance of the FAO was availed of in identifying suitable sites and deciding on the nature of facilities to be provided.

The initial approach was to provide limited landing and berthing facilities such as a jetty, deepening of the entrance channel, provision of a breakwater, market hall, guide lights, etc. Such facilities have already been provided at about 90 sites, the most important of which are Porbander, Mangrol, Veraval, Navabunder and Jaffrabad in Gujarat, Karwar in Karnataka, Ponnani, Balia-patnam, Mopla Bay, Beypore, Azhicode and Vizhinjam in Kerala, Rameswaram, Nagapatnam, Cuddalore and Tuticorin in Tamil Nadu, Kakinada in Andhra Pradesh and Chandipur in Orissa.

With the establishment of the Pre-Investment Survey of Fishing Harbours project at Bangalore in 1968, detailed surveys were undertaken and designs were prepared for the construction of large, self-contained fishing harbours, usually with components such as breakwater, navigation lights, dredged channel and basin, jetties, wharves, auction halls, slipways, boat and net repair sheds, public utilities, electricity, water supply, sewerage, drainage, approach roads and back-up space for fish-based industries, such as ice plants, processing plants, cold storages, etc. On the basis of preinvestment surveys and evaluation, investment decisions are made and the work of construction entrusted to the various state governments. At major ports, however, the entire work of survey, design and construction of fishing harbours is the responsibility of the major Port Trusts.

The cost of construction of fishing harbours at major ports is met by the Central Government, while the cost of construction of fishing harbours at minor ports is shared between the Centre and the states concerned, presently on an equal basis. The fishing harbours under construction or completed at both major and minor ports in 1981 are shown in Appendices 4.1 and 4.2. Planwise outlays and expenditure on fishing harbours at major and minor ports are given in Appendix 4.3.

Commencing from the first Five-Year Plan period, construction of ice plants, freezing plants and cold storages was undertaken. The development of these facilities by plan periods is set out in Appendix 4.4. The Statewise distribution of these facilities is shown in Appendix 4.5.

There are 117 registered boatbuilding yards of which 69 construct wooden boats, 35 are equipped for the construction of large vessels and 13 where FRP boats are constructed. Besides these, there are numerous small boatyards, which are not registered, constructing different types of indigenous craft and small mechanised boats.

Local capability exists for the construction of wooden vessels up to 14 m and steel vessels up to 23 m. Expertise in the construction of larger vessels is in the process of being acquired — a foreign consultant has been engaged to design a large wooden trawler and design and shop-floor drawings have been acquired for indigenous construction of a 23 m shrimp trawler. The Goa shipyard has been strengthened with assistance from the Government of Norway for the construction of large fishing vessels and vessels intended for government departments are under construction under this programme. A government scheme has been announced under which indigenously constructed fishing vessels are eligible for subsidy up to 33% with provision for import of components up to 20% of the value of the vessel.

There are 8 manufacturers of marine diesel engines. The firms, makes and horsepower of the engines and the annual licensed manufacturing capacities are given in Appendix 4.6.

Service stations and workshops providing repair and servicing facilities for fishing boats are available at important fishing centres such as Veraval, Porbander, Bulsar in Gujarat; Satpati, Bassein, Bombay, Ratnagiri and Alibag in Maharashtra; Marmugao in Goa; Karwar, Malpe and Mangalore in Karnataka; Cannanore, Cochin and Quilon in Kerala; Cuddalore, Nagapatnam, Colachel, Rameswaram, Mandapam and Madras in Tamil Nadu; and Kakinada and Visakhapatnam in Andhra Pradesh. Dry-dock and slipway facilities for underwater maintenance are available at Bombay, Goa, Cochin, Mandapam, Madras, Visakhapatnam and Calcutta. Slipways are under construction at fishing harbours such as Cochin, Madras, Visakhapatnam, Ratnagiri, Veraval, Mangrol, Porbander, Kakinada and Bhavanapadu.

Most of the indigenous fishing gears are fabricated by the fisherfolk themselves. There are four public sector net making plants with a manufacturing capacity of over 149 tonnes of synthetic webbing per annum and 20 private sector units with a total capacity of 622 tonnes of synthetic webbing per annum.

Various fishing vessel components such as reverse-reduction gears, stern gear, power-take off clutches, auxiliary engines and machinery, trawl winches and other equipment such as radio telephone, refrigeration equipment and life-saving appliances required by the fishing industry are also manufactured in the country.

5. PRODUCTION

Capture fisheries account for the entire marine fish production. The highest marine fish production of 1.422 million tons was achieved in 1975, after which catches showed a slight decline. This decline is in the traditional sector, while the mechanised sector has been, by and large, maintaining a steady increase, except very recently when this sector was badly affected by the increase in fuel prices. The total annual production between 1969 and 1980 is shown in Appendix 5.1. The composition of the marine fish landings for 1977-80 is given in Appendix 5.6. Appendix 5.7 gives a statewise and specieswise breakdown of the marine fish landings for 1980. The patterns and trends in the marine fishery are diagrammatically represented in Appendices 5.2 to 5.5.

Besides the marine capture fisheries, there is some production from traditional coastal aquaculture. The age-old 'Bhasa bada' system of fishery in West Bengal accounts for about 9,000 ha of impoundments and a production of 3,000 tons of prawn per annum and the system of trapping and holding in the 'Pokhali' paddy fields in Kerala covers about 4,500 ha and produces about 4,000 tons per annum of prawn along with other miscellaneous species.

6. HANDLING AND PROCESSING

Traditional fishing craft do not carry ice and the fish caught is kept exposed to sun and wind. Many of the smaller mechanised fishing boats do not have fish holds and the catch is kept on the deck in baskets. In slightly larger boats fish holds are provided but are not insulated. The use of ice for preservation of fish on board fishing boats is however on the increase. On shore, fish which is to be transported to inland places and processing plants is repacked with ice.

Transportation by road is the most preferred mode of transportation for fish but rail transportation is also widely used. Freezing, canning and curing are the important methods employed for processing the marine fish catch for human consumption. Fish is also processed for production of fish-meal, oils, manure and other industrial commodities.

India's fish catch in 1979 was disposed of as follows: 65.03% by marketing in the wet form, 5.65% by freezing, 22.17% by curing, 0.19% by canning, 5.37% by reduction and 1.59% by miscellaneous processing.

Freezing is mainly carried out for prawns and to a lesser extent for lobster tails, frog legs, cuttle fish and fish. Shrimp is mostly block frozen, fish is blast frozen, while the rest is wrap frozen. 36% of the freezing capacity is in Kerala followed by Maharashtra with 20%.

Canning now accounts for an insignificant proportion of fish processing in view of the high can cost and the preference for aluminium cans in the export market. No commercial undertaking has an aluminium canning line. The only one in the country is the plant used by IFP which is used primarily for demonstration and training. The Statewise canning and fish meal manufacturing capacities are shown in Appendix 6.

Curing as a method of preservation is becoming less and less popular. The demand is mostly in areas such as the hill country, the plantations, etc., where it is difficult to transport fresh fish.

India introduced compulsory pre-shipment inspection of exportable fish products in 1965. The rules governing the inspection of these products were formulated under the Export (Quality Control and Inspection) Act of 1963. Later at the end of 1977, a system of in-process quality control for fish and fishery products was introduced. This was slightly modified in 1980 to allow self-inspection in respect of units having the prescribed facilities.

7. DISTRIBUTION AND MARKETING

A recent market survey has estimated that for India as a whole, 53% of the population in metropolitan cities, 50% in urban areas and 56% in rural locations are fish-eating. On an all-India basis 15% of the non-fishcooking households have at least one fish-eating member. The percentage of fish-eating population ranges from 13% in Jaipur to 95.6% in rural Kerala. Over 76% of the buyers purchase fresh fish only once a week, except in Kerala, where daily purchase is the common procedure. A preponderant portion (85%) of marine fish purchases are consumed the same day, while practically the entire balance (14.5%) is consumed the next day. 70% of the marine fish consuming households purchase fish from retail markets in their locality and the rest from vendors who arrange home delivery. Consumers prefer home delivery and some are willing to/pay extra for this facility, even though the majority of consumers feel that the vendors' margins are high. Quality fish like pomfret, seer and mackerel generally move into metropolitan and urban markets, while cheaper fish like sardines go into the rural areas,

The faster pace in the rise of fish prices, compared to all commodities and food items, is an indication that the demand for fish has outstripped supplies. A recent study on 'Marine fish marketing in India' has placed the total aggregated demand for marine fish by 1984-85 at 2.9 million tons at an annual compound growth rate of 15%, while the aggregated supply of marine fish, including catches from deep-sea fishing, is expected to reach only 1.57 to 1.67 million tons by that time, indicating thereby that the gulf between demand and supply would further widen in the coming years.

In the absence of adequate marketing infrastructure, 97.8% of marine fish consumption is in the coastal states, whose total population is only 50.6%. As much as 49.4% of the marine fish is consumed in the producing centres and nearby areas (say less than 40 km from the coast) about 45.4% move up to 200 km, while only 4.5% move beyond 200 km. The metropolitan cities and urban locations account for 40.12% of the marine fish consumption, even though they represent only 23.12% of the total population.

There are six principal types of market intermediaries, viz., auctioneers, purchase commission agents, wholesalers, retail commission agents, retailers and vendors. Processors are the additional link in this chain for the dry fish trade. However, 16.4% of the total fresh fish is sold directly through retailers/vendors, and 70% pass through three intermediaries or less. Extension of loans by auctioneers, wholesalers and purchase commission agents is quite common in all the States. However, 43.5% of the fresh fish is sold by fishermen by auction. Direct sales are at pre-fixed prices. Fishermen's share of the consumer price is the highest (95%) in the case of direct sales to consumers and lowest (21.9%) in sales involving the multilocational distribution system.

Wholesale and retail prices of fish naturally differ from place to place. The price of fish is also influenced by seasonal availability and demand. Wholesale prices reported by the Directorate of Economics and Statistics of the Ministry of Agriculture on the last Friday in each month for nine months of 1981 are given in Table 7.1.

Table 7.1

Wholesale prices of fish (Rs./quintal) in some important market centres

| Market centre | Variety | Jan. | Feb. | Mar. | April | May | June | July | Aug. | Sept. |
|---------------|---------|------|------|------|-------|------|------|-------|-------|-------|
| Calcutta | Rohu | 1600 | 1300 | 1600 | 1600 | 1600 | 1700 | 1700* | 1800* | 1800 |
| | Bhekti | 1400 | 1400 | 1500 | 1500 | 1500 | 1500 | 1500* | 1500* | 1500 |
| | Hilsa | 1700 | N.A. | N.A. | N.S. | 1400 | 1500 | 1500 | 1600 | 1600 |
| Bombay | Catfish | 650 | 550 | 425 | N.A. | 1000 | N.A. | N.A. | a75 | a50 |
| | Pomfret | 2200 | 1650 | 1650 | 1760 | 1760 | N.A. | N.A. | 2860 | 1980 |
| Madras | Catfish | 560 | 570 | 575 | 560 | 570 | 570 | 570 | N.R. | N.R. |
| | Prawn | 800 | 810 | 850 | 850 | 870 | 870 | 870 | N.R. | N.R. |
| | Pomfret | 1000 | 1200 | 1200 | 1200 | 1200 | 1200 | 1300 | N.R. | N.R. |
| | Seer | 1300 | 1300 | 1310 | 1300 | 1300 | 1300 | 1200 | N.R. | N.R. |

N.A. — Not available; N.S. — No supply; N.R. — Not reported; * — Relates to the previous week.

Calcutta is the largest market for fish in India. The city has six wholesale markets of which the largest is the Howrah market which handles about 64% of a total turnover of about 137,000 tonnes of fish per annum. During 1974-76, as much as 92-94% of the fish reaching Calcutta markets arrived by rail from over 10 states.

Bombay is the next largest market. Unlike Calcutta, Bombay meets the bulk of the fish consumed from landings at 20 centres within Greater Bombay, of which Sassoon dock, Kasara Bunder and Versova are the most important. The biggest wholesale market is the Chatrapati Shivaji market which handles about 50% of the total turnover of fish in Bombay. However, fish is sold in this market only from 6 a.m. to 8 a.m. after which the floor is cleaned and vegetables take the place of fish. The Sewree dry fish market handles the bulk of the dry fish trade. There are about 4000 retailers of fish in Bombay.

Delhi does not have an organised wholesale market, but about 30 wholesale shops operate in the by-lanes of Urdu Bazaar. According to a 1976 survey, there were 148 retail shops in Delhi.

None of the wholesale markets have proper storage facilities. Improvised stores are used for storing fish on ice for short periods.

8. EXPORT AND IMPORT

India had been a traditional exporter of dried fish to countries like Sri Lanka, Malaysia and Hong Kong, and dried fish formed the bulk of Indian marine products exports till 1961. Exports of frozen foods from India started in 1953, when an amount of Rs. 60,000 was realised. Then onwards, there has been a rapid and progressive increase in the export of marine products. Table 8.1 shows the increase in exports in the period after 1962/63.

Table 8.1
Exports of Indian marine products

| | 1962/63 | 1973/74 | 1979/80 |
|---------------------|---------|---------|---------|
| Quantity (tonnes) | 11,161 | 52,279 | 86,401 |
| Value (Rs. million) | 42 | 895 | 2,488 |

About 62 different items of fish and fishery products are exported from India. The most important items are frozen shrimp and fresh and frozen fish. The principal markets are Japan, USA, West European countries and Australia.

Appendices 8.1 and 8.2 give the export pattern of marine products for 1977/78 to 1979/80.

Except for the period between 1972/73 and 1975/76 when India imported fish from Bangladesh, there have not been any sizeable imports of fish into India during recent years. Details of fish imports for the years 1974/75 to 1979/80 are shown in the table below:

Table 8.2
Import of fish into India

| | 1974/75 | 1975/76 | 1976/77 | 1977/78 | 1978/79 | 1979/80 |
|--------------------------|---------|---------|---------|---------|---------|---------|
| Quantity (tonnes) | 2,302 | 1,910 | 29 | 45 | 18 | 26 |
| Value (Rs. in thousands) | 15,650 | 11,230 | 180 | 476 | 1200 | 370 |

9. COASTAL AQUACULTURE

Coastal aquaculture in India is a promising area of development for increasing fish production, boosting foreign exchange earnings through export of marine products, providing more employment opportunities, raising incomes, and improving the economy of the coastal belt through related economic activities.

Only rough estimates are available about the potential for coastal aquaculture. The immediate prospects are in brackishwater fish and prawn culture while the prospects for mariculture are subject to technological improvements and considerable changes in the attitudes and food habits of the local people.

The practice of trapping and holding fish and prawn is an old tradition in the deep water paddy (Pakhali) fields of Kerala, mostly reclaimed from the backwaters. When the rains stop, the water in the backwaters and paddy fields turns brackish and no more paddy cultivation is possible until the rains start again and flush out the brackish water. By providing sluice-gates to the paddy fields, the latter are naturally stocked with fish and prawn fry that come with the tides, particularly during the new moon and full moon tides. They grow quickly, foraging for the food brought in by the tides and on the hay stumps and filamentous algae available in the paddy fields. Harvesting is done by straining the water during low tides associated with spring and neap tides.

In West Bengal, where the tide is much higher, the saline effect is felt far up in the Sunderbans estuary. Here large areas have been impounded by constructing perimeter dykes forming 'bheels'. During the high tides, generally from March onwards, water containing prawn and fish seed is drawn into the bheels. The seed is allowed to grow for a few months and harvesting starts by July.

With the boom in the shrimp export trade, farmers started stocking young ones of fast growing shrimp and production increased. Currently about 4,500 ha of paddy fields in Kerala, 9,000 ha of bheries in West Bengal, and a slightly smaller extent of land in Karnataka are under fish and prawn culture.

Large stretches of land, previously subject to saline ingress, have been brought under paddy by elaborate saline protection works. The whole of Kuttanad in Kerala comes within this category. These saline protection works have to some extent affected the natural fishery, while paddy cultivation has not been very successful. With minor modifications, more lucrative use could be made of such impoundments in Kerala as well as in other states for brackish water fish and prawn culture. Besides, the Rann of Kutch, the Khar lands of Maharashtra, Goa and Karnataka, the coastal backwaters of Kerala and Tamil Nadu, the large lakes like Pulicat and Chilka and the estuarine areas of river systems and their adjoining regions, impoundments used for storing sea water for salt-making, etc., are all areas with potential for brackishwater fish/prawn culture. Table 9.1 gives an estimate of the areas available for brackishwater fish culture and the extent of utilisation.

Table 9.1
Areas for brackishwater fish culture

| Name of state | Area available (in 000 ha.) | Area currently under culture (ha.) |
|---------------------------|--------------------------------|---------------------------------------|
| Gujarat | 37% | 88 |
| Maharashtra | 81 | — |
| Goa | 19 | 10 |
| Karnataka | 8 | 4800 |
| Kerala | 122 | 5117 |
| Tamil Nadu | 71 | 25 |
| Pondicherry | NA | — |
| Andhra Pradesh | 64 | 25 |
| Orissa | 299 | — |
| West Bengal | 405 | 9000 |
| Andaman & Nicobar Islands | NA | — |
| Lakshadweep | Nil | — |
| Total | 1447 | 19065 |

Besides biological factors, ecological factors such as tides, cyclones, temperature, relative humidity, nature of soil, etc., determine the suitability of water areas for brackishwater fish culture. Tides are generally high in the higher latitudes. They are very high (about 6 metres) in the narrow inlets like the Gulf of Cambay, archipelago region of Sunderbans, etc., while they are very low (about 0.5 metre) at the southern end of India. Where the tidal range is less than the range of 1.5 to 2.5 m considered ideal, filling and draining of ponds would require use of pumps. Coastal soil is generally sandy, porous and poor in fertility. Excessive evaporation and consequent increase in salinity are limiting factors in shallow ponds, particularly where water exchange is poor. One of the greatest risks is from cyclones. Another problem encountered is the high acidity of soil, particularly along the south-west coast of India. Sudden rains often lower salinity and more especially pH to unsafe levels and periodic flushing is necessary to maintain pond pH within safe limits.

Some preliminary mariculture trials have been conducted on fish culture in pens and sea ranches. There is good scope for cage culture of fish and crustaceans in the coastal regions, especially in the estuarine areas. Mariculture, however, has not developed on commercial lines due to the relative absence of protected bays, rough seas during the monsoon season and the scope for cheaper production through capture fisheries. Hardly any work on cage culture has been done so far.

Since the main input for all forms of aquaculture is the seed, as a first step in promoting coastal aquaculture, studies have been undertaken by both inland and marine fisheries research institutes on the collection of fish seed from natural sources. Several prawn varieties are available and are widely distributed. Non-penaeid prawn dominates the Gujarat and Maharashtra regions, white prawn (*Penaeus indicus*) occurs at Mangalore, Waltair and Puri, pink prawn (*Metapenaeus dobsoni*) at Calicut and Cochin, brown prawn (*Metapenaeus monoceros*) at Kakinada and tiger prawn (*Penaeus monodon*) along the coasts of West Bengal, Orissa, and parts of Andhra Pradesh. White prawn fry is generally available during February and March, while tiger prawn fry is available for 3 to 4 months from April. Chanos fry appear at the beginning of summer, while mullet fry is abundant in lakes and estuaries during the winter months.

For efficient aquaculture, the availability of fry should match operational requirements. Along the east coast three crops of prawn could be raised if prawn fry is available during January, April-May and August. Along the west coast two crops are possible if prawn fry is available once in October and again in February. A third crop of freshwater prawn is possible if fry of freshwater prawn is available by May-June, i.e., by the time rains start and salinity goes down.

Commercial fish and prawn seed farms do not exist. The technologies of maturation and breeding — of induced breeding of fish through hypophysation and of prawn through unilateral eye-stalk ablation -are known, but still require a great deal of refinement. Many research and development agencies, including some in the private sector, are engaged in this work.

Available data on the rate of fish/prawn production achieved in experimental coastal aquaculture under the All India Coordinated Research Project on brackishwater fish culture in various fish/prawn farms, mostly through stocking of the young ones of fast-growing species collected from their natural environments, are summarised in Appendix 9.1.

The culture of both brown and green mussel on ropes suspended from floating rafts in bays and open seas has been carried out by the Central Marine Fisheries Research institute.

Production at the rate of 10-15 kg per metre length of rope has been obtained in 5-6 months. While this high production is indicative of good potential, many related problems have to be solved. The most important problem is the development of an economically priced raft that can take the load and withstand the monsoon surges. Secondly, mussel meat is still a cheap poor man's food in India. Demand is limited both within India and outside. Production through breeding and artificial spat collection, use of ropes and rafts, etc., would not be economically viable unless suitable remunerative markets are tapped.

Coastal aquaculture poses the question as to who should be the allottees of low-lying coastal land which is largely Government-owned at present. While the larger farmers and industrial entrepreneurs are better equipped for larger scale development of coastal aquaculture, both financially and due to their capacity to absorb modern technology, the landless labourers and fisherfolk, etc., also have competing claims. Only the Government of Andhra Pradesh has come out with a policy of long-term leases of such areas to small, medium and larger farmers.

10. SOCIO-ECONOMICS

The total fisherfolk population, both marine and inland, was assessed in 1979 at 5,375,800, of whom 1,786,600 were in active employment. Details regarding the latter are given in Table 10.1.

Table 10.1
Employment of fisherfolk (1979)

| Type of employment | Total Number | Percentage |
|--------------------|------------------|------------|
| Full-time fishing | 453,300 | 25.37 |
| Part-time fishing | 439,100 | 24.58 |
| Fish marketing | 364,300 | 20.40 |
| Net-mending | 209,500 | 11.72 |
| Fish-processing | 91,100 | 5.10 |
| Other work | 229,300 | 12.83 |
| Total | 1,786,600 | |

Statewise figures (except for Maharashtra for which figures are not available) of marine fishing villages, landing centres, population, educational status and employment are given in Appendix 10.1.

Besides fishing, fishermen also carry on other vocations such as boating, seafaring, salt-making and agriculture.

The fisherfolk of India belong to all the major religions of the country, viz., Hinduism, Islam and Christianity. In each state they belong to several different castes. The castes often have a social organisation of their own, with their own chiefs who exercise great authority over certain socio-economic aspects of the life of the fisherfolk.

The average size of a fisherfolk family varies between 4.7 and 8.6 in different states.

Although the majority of them are poor, there has been considerable improvement in the living conditions of fisherfolk in recent years. Many fishermen have organised themselves to form welfare or self-help organisations in several states.

Fisherwomen play a very important part in the economic as well as the social and domestic life of fisherfolk. They take an active part in net-making, net-mending and sale of fish in the nearby markets, besides attending to domestic work.

There is no uniform pattern in the socio-economic organisation of fishery activities. There are many fishermen who work alone with a single cast net or line. From this simple unit, there is a progressive increase in complexity -some making use of boats and gears owned by a person or group of persons; some sharing the catches among the workers and the owner of a fishing unit; some delivering the catch to pre-identified agencies. Mostly these are linked with prior agreements and arrangements for finance, involving middlemen to whom a large number of fishermen is perennially indebted.

Table 10.2 gives some information in relation to boat ownership based on a limited survey conducted by the Programme Evaluation Organisation of the Planning Commission in 1968-69.

Table 10.2
Boat ownership patterns in different maritime states

| State | Owners | Partners/ percentage | Wage earners |
|----------------|--------|-------------------------|--------------|
| Gujarat | 66.7 | 6.6 | 26.7 |
| Maharashtra | 44.9 | 15.6 | 37.5 |
| Karnataka | 50.0 | 50.0 | — |
| Kerala | 27.8 | 22.2 | 50.0 |
| Tamil Nadu | 50.0 | 50.0 | — |
| Andhra Pradesh | 39.0 | ? | ? |
| Orissa | 50.0 | 50.0 | — |
| West Bengal | 50.0 | — | 50.0 |

Very little information is available on the income of fishing families or on their spending patterns. Information on income per family and per capita income of fishermen operating mechanised and non-mechanised craft is given in Table 10.3 and is also based on data collected by the Programme Evaluation Organisation of the Planning Commission during the survey conducted in 1968-69 for evaluating the programme of mechanisation of fishing boats.

Table 10.3

Income of fishermen operating country craft and mechanised boats (1968-69)

| State | Total income (Rs.) per family operating | | Per capita income (Rs.) -operators of | |
|----------------|---|------------------|---------------------------------------|------------------|
| | Country craft | Mechanised craft | Country craft | Mechanised craft |
| Gujarat | 3620 | 5165 | 543 | 666 |
| Maharashtra | 1592.8 | 2373.8 | 57.7 | 121.2 |
| Karnataka | 2572 | 2558 | 362 | 351 |
| Kerala | 578 | 920 | 216 | 75 |
| Tamil Nadu | 4387.4 | 4085.8 | 923.7 | 558.3 |
| Andhra Pradesh | 4437 | 2803 | 600 | 479 |
| Orissa | 1480 | 2524 | 172 | 312 |
| West Bengal | 8813 | 2341 | 1855 | 431 |

Although the majority of fisherfolk are still illiterate, the literacy rate among them has considerably improved in recent years, particularly after the formulation of a national policy in 1968 to provide free and compulsory education up to the age of 14. Some of the states have fisheries schools in fishing villages, and fisheries has been included as one of the vocational training subjects in schools in some states.

As regards housing, medical and other facilities, the States as well as the Central Government have drawn up various schemes for provision of housing and medical facilities, supply of potable water and construction of roads. During the Fifth Plan period, a centrally sponsored scheme for the provision of infrastructure in coastal fishing villages was operated. Under this scheme, which was later transferred to the state sector, a few fishing villages were selected for development; approach roads, water supply, fish curing yards, ice plants, insulated trailers, fish godowns, etc., were provided.

11. FISHERIES ADMINISTRATION AND INSTITUTIONS

11.1 Fisheries Administration

Under the Indian Constitution, both the Union Government and States share responsibilities for the development of fisheries. Each of the States is directly responsible for the development of fisheries within the territorial waters of the sea and the inland waters. The Union Government is responsible for the development of fisheries beyond the territorial waters and for fisheries research, although these are shared by the State Governments as well.

The Fisheries Wing in the Department of Agriculture under the Ministry of Agriculture, Government of India, is in overall charge of all important matters relating to policy and administration of the fisheries of the country. It is responsible for the formulation of national policies and programmes of fisheries development, fishing harbours, processing and preservation of fish, fisheries education and training, fish trade, etc., so designed as to achieve the optimum development and utilisation on modern lines of the country's fishery resources and to achieve the objective of self-reliance in this field. It is also responsible for taking all necessary steps for making available timely and adequate supply of inputs and services required; for participating in international organisations, promoting bilateral and multilateral cooperation and collection and maintenance of relevant statistics. It assists State Governments in formulation of policy, plans and projects, and in the setting up of fisheries corporations, and offers technical advice and guidance whenever required.

Apart from the Department of Agriculture at the Union Government level, the Ministry of commerce also looks after certain functions concerning fisheries. These relate to export promotion, developing the production base, and quality control.

Fisheries education and research are the responsibilities of the Indian Council of Agricultural Research (ICAR), a registered society under the Department of Agricultural Research and Education (DARE). DARE is under the Ministry of Agriculture and provides ICAR with the requisite linkages with central and state governments who are the agencies to extend the technology evolved at the research institutes to the field.

In order to plan, coordinate and develop indigenous capability in oceanographic research, an Oceanic Science Technology Agency (OSTA) has been established. OSTA, which was under the Union Department of Science and Technology, has now been transferred to the new Department of Ocean Development.

The Union Minister for Agriculture is in overall charge of fisheries in the country. He is assisted by the Minister of State. The Secretary (Agriculture), who is the official head of the Department of Agriculture and the Additional Secretary (Relief and Fisheries) hold charge of fisheries. The Joint Secretary is the head of the Fisheries Division in the Department of Agriculture. On the administrative side, he is assisted by a Deputy Secretary and an Under-Secretary. On the technical side, the Joint Commissioner was formerly the principal adviser to the Government on all matters concerned with fisheries development. He has now been replaced by the Fisheries Development Commissioner. The latter is assisted by Deputy Commissioners and Assistant Commissioners. The Union Minister for Agriculture who has overall charge of the Department of Agricultural Research and Education (DARE) is also the President of the Indian Council of Agricultural Research (ICAR). In all matters of policy and administration relating to the Department, he is assisted by a Minister of State. The Director General, ICAR, who is also Secretary to DARE, is the principal Executive Officer and Vice-President of ICAR. On the administrative side, he is assisted by the Secretary of the Council, who is a Joint Secretary to the Government of India, and Additional Secretaries and Under-Secretaries. On the technical side, the Director General is assisted by a Deputy Director General (Animal Sciences), an Assistant Director General (Fisheries) and a Scientist (Fisheries). The organisational set-up of the fisheries administration in the Union Government is shown in Appendix 11.1.

There is considerable diversity in the organisation of fisheries departments in the different states. In general, one of the ministers of the State Government is in overall charge of fisheries. The Secretary in charge of fisheries is the principal secretariat officer. The Directorates of Fisheries are headed by the Director of Fisheries and are responsible for the planning and implementation of fisheries programmes. The Director of Fisheries may be either a technical officer or an officer from the Indian Administrative Service. He is assisted by Joint Directors, Deputy Directors, Assistant Directors and Superintendents of Fisheries, District Fishery Officers and Wardens, who are in charge of districts or particular programmes. Under these district officers, Inspectors of Fisheries and other field officers function.

In the Union Territories, the fisheries programmes are administered by Directorates of Fisheries.

11.2 Institutes

A chart showing the nodal organisations and the specialised institutes under their control is found in Appendix 11.2.

11.2.1 *Research and Development Institutes*

11.2.1.1 *Central Marine Fisheries Research Institute (CMFRI)*

The Institute was established in 1947 by the then Ministry of Food and Agriculture. It came under the control of ICAR in 1967. The headquarters of the Institute is at Cochin and it has a regional centre at Mandapam Camp in Tamil Nadu. Besides these, there are 11 research centres and 29 field centres on both coasts. Field experimental stations are located at Narakkal, Kovalam, Tuticorin, Mandapam, Vizhinjam and Calicut.

The overall objectives of the Institute are to conduct short-term and long-term multi-disciplinary researches on the marine capture and culture fisheries of the country. It thus seeks to provide research support for the rational exploitation, conservation and management of marine and brackishwater resources, and development support for the growth and stability of the industrial, artisanal, and culture fisheries. Its functions include transfer of technology, dissemination of information and education, training and extension.

The scientific work of the Institute is organised under nine divisions, viz., Fishery Resources Assessment; Pelagic Fisheries; Demersal Fisheries; Crustacean Fisheries; Molluscan Fisheries; Fishery Environment Management; Physiology, Nutrition and Pathology; Extension and Fishery Economics; Library and Documentation ; and under 7 other activities, viz., Inter-divisional and Institutional projects; Sponsored Projects; UNDP/FAO Centre of Advanced Studies in Mariculture; Training Centre and Krishi Vigyan Kendra; Training Programmes; Operational Research Project; and Lab-to-Land Programme.

The Institute has 960 staff members, including a scientific staff of 193, technical staff of 364, administrative staff of 141 and supporting staff of 262. During 1979-80 the Institute had a budget of Rs. 20.1 million.

The Institute's major activities in achieving the various objectives *inter alia* include survey of the Exclusive Economic Zone for assessing the fishery resources; estimation of marine fish production and monitoring of the fishery resources in the traditional grounds in relation to fishing effort; studies on primary and secondary production; assessment of potential yield and MSY levels of important fisheries; fisheries information and forecasting ; environmental monitoring ; development and standardisation of mariculture technologies for increasing fish and shellfish production by upgrading research and providing post-graduate research and education facilities; extension education facilities in mariculture; extension education programme; training programmes and consultancy services.

11.2.1.2 Central Institute of Fisheries Technology (CIFT)

CIFT was established in 1957 with its headquarters at Cochin and is now under the Indian Council of Agricultural Research. Research centres of the institute function at Calicut (Kerala), Panaji (Goa), Bombay (Maharashtra), Veraval (Gujarat), Burla (Orissa), Kakinada (Andhra Pradesh) and Madras (Tamil Nadu).

The aims of CIFT are to develop improved fishing techniques, gear, craft and implements; to develop improved and new technology for the optimum and economic utilisation of fish catch ; to develop technology for economic utilisation of wastes from the fishery industry and also fish and shellfish which do not have a ready market for human consumption; to popularise the research results; to provide a forum for feedback to the Institute on technical problems and to conduct short-term refresher training courses in the improved technology evolved.

The Institute is organised into six divisions- craft; gear; processing and packaging; bio-chemistry, nutrition and microbiology; engineering ; and extension, information and statistics.

11.2.1.3 Central Inland Fisheries Research Institute (CIFRI)

The Institute was established in 1947 at Calcutta, under the then Ministry of Food and Agriculture, Government of India. The administrative control of the Institute was taken over by the ICAR in 1967. The headquarters of the Institute is at Barrackpore near Calcutta.

The main objective of the Institute is to elucidate the scientific principles which can be applied for full utilisation of all available inland waters of the country for maximising fish production. This objective entails evolving sound fish husbandry techniques; acquiring understanding of the biology of food fishes; conducting investigations on the hydrology and ecology of different waters; performing research on population dynamics of fish in natural waters, such as rivers, lakes, reservoirs, estuaries, etc. ; formulating artificial feeds and evolving feeding techniques; and developing fishery management techniques relating to both fresh and brackishwater environments.

The Institute presently has 37 centres spread across the country. It has a total staff of 857 consisting of 206 scientific, 120 technical and 531 non-technical and supporting staff. In 1980/81 the Institute had a budget provision of Rs. 17.6 million.

The research work currently done at CIFRI pertains to the following: seed production: bundh breeding, induced breeding of fish, prawn and frog; rearing of spawn; culture investigation and allied topics; fish culture in running water and in recirculatory filtering pond systems, cold water fish and prawn culture, cage culture, culture systems integrating fish, livestock and agriculture; culture of carp, hilsa, air-breathing fish, other catfish, etc. ; fish genetics and nutrition, fish health, weed control, farm designing, etc.; economic investigations; fishery management; resource investigations; and ancillary projects such as energy flow and radiotracer techniques in aquatic ecosystems, adaptive research in fish culture and fisheries extension.

In addition to the research activities, state government employees are trained through Krishi Vigyan Kendra and the Teachers Training Centre. The Institute also supplies technical information on inland fisheries.

11.2.1.4 National Institute of Oceanography (NIO)

The National Institute of Oceanography was established in 1966 under the Council of Scientific and Industrial Research (CSIR). The headquarters of the institute is at Panaji in Goa and it has three regional centres at Visakhapatnam, Cochin and Bombay. The institute is engaged in studies of the seas around India with the objective of making proper and judicious use of their resources.

The institute is organised in six divisions. Research on 35 projects and 36 sponsored projects are in progress at the institute. Important projects relating to fisheries include physical and chemical oceanography; protection of the marine environment and monitoring of pollutants along the Indian coast; characteristics of estuarine regions of major Indian rivers; survey of biological resources: coastal aquaculture etc.

The institute has 350 staff members. It had a budget provision of Rs. 22.346 million during 1980-81.

11.2.1.5 Integrated Fisheries Project (IFP)

Until 1973 this was known as the Indo-Norwegian Project. It was started in 1952 as an area development project with the objective of uplifting the fishing communities of Neendakara and Saktikulangara villages in Kerala State.

During the first phase between 1952 and 1963, the project established in the project area a boatbuilding yard, a workshop, a training centre, an ice-cum-freezing plant, a health centre and a pipe factory for protected water supply and assisted in the all-round development of these villages. At the end of the first phase, these establishments were handed over to the Government of Kerala.

The second phase was started in 1963 with Cochin as headquarters. The project extended Neendakara-type fishery development activities to Mandapam in Tamil Nadu, Cannanore in Kerala and Karwar in Karnataka. Exploratory and experimental deep sea fishing was also taken up from Cochin, large vessels were acquired, and related facilities such as slipway, workshop, fish landing jetty, processing and marketing facilities established.

At the end of the second phase in 1972, the activities at Mandapam, Cannanore and Karwar were vested in the respective state fisheries departments, while the project activities at Cochin continued as a Central Government project under the name Integrated Fisheries Project.

The project now carries out a marine fishery demonstration programme of an integrated nature. It provides training in refrigeration, processing, and purse seining and extends sea and workshop qualifying time facilities to CIFNET trainees. The details of the training courses are shown in Table 11.2.1 5.1.

Table 11.2.1.5.1

Training facilities and courses conducted by IFP

| Name of Course | Intake capacity (No/Batch) | Duration (month) | Total No. of candidates to be trained |
|--|----------------------------|------------------|---------------------------------------|
| 1. Refrigeration technician | 20 | 10 | 216 |
| 2. Processing technician | 12 | 6 | 226 |
| 3. Master fisherman in purse-seining | 9 | 10 | 46 |
| 4. Qualifying time for fishing second-hand | 25 | 33 | 115 |
| 5. Qualifying time for engine driver | 6 | 18 | 34 |

IFP has a fleet of 12 vessels and related facilities such as slipway, marine workshops, fishing gear repair and maintenance section, electronic equipment repair unit and processing, product development and marketing facilities.

The project has a staff of 392 and an annual budget provision of about Rs. 16 million.

Fish processing and marketing are distinctive activities of the IFP, and a proposal to reconstitute it as a fish processing and marketing project is under consideration, particularly since deep sea fishing will become viable only if a higher value can be realised from the miscellaneous varieties that form the bulk of the deep sea catches for which there is only a limited market at present.

11.2.1.6 Exploratory Fisheries Project (EFP)

EFP was known until 1974 as Deep Sea Fishing Station, Bombay and was established in 1946. The headquarters of EFP is at Bombay. There are 12 operational bases at Porbander, Veraval, Bombay, Goa, Mangalore, Cochin, Tuticorin, Madras, Visakhapatnam, Paradeep, Calcutta and Port Blair. A new operational base has been recently established at Vizhinjam to conduct exploratory surveys of the Wadge Bank as a part of the Vizhinjam fishing harbour project development.

The objectives of EFP are to carry out exploratory work in respect of charting of fishing grounds, fishing seasons, types of fish available for exploitation and suitability of different fishing vessels and gears; to train personnel for modern fishing operations; to test the commercial feasibility of deep fishing; and to make available requisite data and information towards the expansion of the fishing industry.

The project has at present a fleet of 28 fishing vessels, of which seven are large-sized vessels of 32-40 metre overall length. Three more vessels of 36 metre length are under construction. While the older vessels are bottom trawlers, the recent additions are equipped for pelagic trawling, purse-seining, longlining and squid jigging.

The estimated capital investment on the project is Rs. 300 million and the annual recurring expenditure is Rs. 25 million.

The project carries out exploratory fishing in unexplored and under-explored areas; and experimental fishing in explored areas to establish economic viability and help devise appropriate craft and gear for commercial exploitation of the located resources. It also provides in-vessel training to candidates who have successfully completed the institutional training.

With the acquisition of large vessels, EFP plans to complete a preliminary survey of the bottom as well as mid-water and pelagic fishery resources of the entire 200 mile Exclusive Economic Zone during the next five years.

11.2.1.7 Pre-Investment Survey of Fishing Harbours (PISFH)

PISFH was established with UNDP special fund assistance in 1968, initially for a period of five years. SIDA provided funding for two more years. Thereafter it has been a national project fully funded by the Government of India. The objective of PISFH is to conduct economic and engineering investigations to locate prospective sites for fishing harbours and to prepare project reports.

There are 58 members on the staff of the project and the annual expenditure is in the region of Rs. 1 million.

The main activities of PISFH cover engineering and economic studies, and the preparation of feasibility reports to facilitate investment decisions. It also provides construction designs, drawings and specifications for approved harbour projects, monitors progress in construction and assists states, as required, in the preparation of tender documents, etc. In recent years, the project has also been providing assistance to states and other agencies in the design of brackishwater fish farms.

A proposal is under consideration to enlarge the scope of PISFH and make it undertake feasibility studies of brackishwater fish farms in addition to fishing harbours.

11.2.1.8 Marine Products Export Development Authority (MPEDA)

MPEDA is the successor to the Marine Products Export Promotion Council set up in the Ministry of Commerce in 1961. It was established in 1972 by an Act of Parliament (Act No. 13 of 1972). MPEDA has its headquarters at Cochin, regional offices at Calcutta, Bhubaneswar, Cochin and Bombay and trade promotion offices at Tokyo and New Delhi.

MPEDA is a statutory authority consisting of 30 members, viz., a Chairman, a Director, members of Parliament, representatives of the Union Ministries of Agriculture, Finance, Foreign Trade, Industry, Shipping and Transport and of maritime states/union territories; owners of fishing vessels, representatives of marine product processing, storage, transport research and other interests. The Chairman, Director and Secretary are appointed by the Government. The main objective of the authority is to develop the marine products industry with special reference to exports, MPEDA has a staff strength of 300 and an annual budget of Rs. 20 million, of which about Rs. 18 million is earmarked for developmental activities.

The activities of MPEDA broadly relate to development, market and product research, and publicity and propaganda.

The development strategy is aimed at increasing value realisation for existing products, increasing production through adoption of appropriate capture and culture practices, diversifying the product range and improving quality.

In order to improve the quality of fish products, MPEDA has prescribed standards for fishing vessels, peeling sheds, frog cutting centres, processing plants and transportation. All processing plants are encouraged to have their own mini-laboratories with qualified personnel, the cost of which is subsidised by the MPEDA. Subsidies are also given for improving peeling sheds, putting up fish landing platforms and purchase of insulated fish boxes. Extension programmes are carried out in prawn farming and in educating workers in the hygienic handling of sea food. Overseas market surveys are conducted and commodity notes and country profiles circulated. Market intelligence in the form of ruling prices in major markets, statistics of fish landing in producing countries, cold storage holdings, etc., are mailed on a weekly basis. Trade promotion offices are maintained at New Delhi and Tokyo for effective market intelligence and promotion. The research and product development wing transfers processing and packaging technology from research institutions to the industry.

New and value-added products are given preference for exhibition in trade fairs. Subsidies are given for air-freighting samples and where possible assistance is given in respect of overseas sales promotion visits. MPEDA organises the Indian Sea Food Trade Fair biennially, and also regularly participates in major food exhibitions all over the world.

11.2.2 Training Institutes

11.2.2.1 Central Institute of Fisheries Education (CIFE)

CIFE was established at Bombay in July 1961 under the Ministry of Agriculture. Its administration was transferred to ICAR in 1979. The objective of the Institute is to train fisheries officers in service in various states in the country by means of a comprehensive course of fisheries education aimed at equipping them with the technical know-how necessary for implementing fisheries development projects. A limited number of private candidates and nominees from the industry and foreign countries are also admitted.

Under the Sixth Five-Year Plan, the Institute will have seven departments, viz., ocean management and marine fisheries; fishing technology; processing and quality control; inland fisheries; aquaculture; economics and administration ; and project planning and evaluation.

CIFE has well equipped class rooms, a laboratory, farm and hostel facilities for students. It has four fishery training vessels of 38', 50', 55' and 120' respectively, equipped for effective instruction in marine fishing techniques, fishery biology and oceanography. There are two field stations in Andhra Pradesh, one for brackishwater fish culture (at Kakinada) and the other for fresh water fish culture (at Balabhadrapuram) at which students receive field training in all aspects of fish culture work.

The Institute offers a two-year post-graduate diploma course in fishery science. The syllabus covers fisheries biology (inland and marine), fish processing technology, fishing technology, fisheries administration and economics, fisheries statistics, marketing and cooperation.

On successful completion of the course, the institute awards an Associate Diploma which is recognised as an alternative qualification to an M.Sc. degree in biological sciences of Indian universities for purposes of recruitment to posts of fisheries officers and other higher posts. A total of 625 students would have received training at the institute by 1981 – 82.

The institute has 269 staff members and its budget provision during 1981 – 82 is Rs. 9.72 million. The Sixth Plan outlay is in the order of Rs. 49.00 million.

The institute's primary concern is the training of senior level fishery officers. It also has a number of subordinate establishments for providing junior level training courses, details of which are given below :

Inland Fisheries Training Unit, Barrackpore

Started in 1947, the unit offers a one-year certificate course in inland fisheries development and administration to candidates sponsored by states, private candidates and nominees from foreign countries. The intake capacity is 40 per year. The entry qualification to the course is a B.Sc. degree with zoology as one of the subjects. A total of 989 students would have received training at this unit by 1981-82.

Regional Training Centre for Inland Fisheries Operatives, Agra

Established in 1967 to impart organised training in inland fish culture practices, the centre offers a 6-month certificate course to nominees of state governments as well as private candidates. The intake capacity is 40 per batch. The entry qualification is the secondary school leaving certificate. The Centre has so far trained 702 persons.

Central Fisheries Extension Training Centre, Hyderabad

The Centre was set up in 1973 for imparting specialised training in extension techniques in fish culture at the post-graduate level, mainly for in-service personnel from different states in the country. The duration of the course is 10 months; intake capacity is 25 for each session. This centre has so far trained 162 persons.

CIFE also conducts periodic *ad hoc* training courses on specialised subjects and conducts workshops either independently or in collaboration with other agencies.

11.2.2.2 Central institute of Fisheries Nautical and Engineering Training (CIFNET)

The institute, known until 1977 as Central Institute of Fisheries Operatives, was established at Cochin in 1963. A unit of this institute was established at Madras in 1968 and at Visakhapatnam in 1981. The purpose of the institute is to train various categories of fisheries operatives to man and provide supporting services for the operation of deep sea fishing vessels.

The teaching facilities of the institute are organised under five divisions -seamanship and navigation; marine engineering; craft and gear; boatbuilding; vessel maintenance and operation. The institute has well equipped workshops and laboratories. It has nine training vessels, six of which are over 28 metres long. They are equipped for stern trawling, pair trawling, purse-seining and longlining. The institute runs trainees' hostels at Cochin, Madras and Visakhapatnam.

The institute has a total staff of 302.

The institute provides institutional and practical training to candidates intending to appear for various competency certificate examinations-skipper, engineer, fishing second hand and engine driver — conducted by the Mercantile Marine Department. It also trains boatbuilders, shore mechanics, gear technicians, radio telephone operators and teachers for fishermen training centres. The details of these courses are set out in Table 11.2.2.2.1.

Table 11.2.2.2.1
Duration and intake of training courses for
marine fisheries operatives at CIFNET

| Course | Duration (months) | Intake capacity per course | | |
|------------------------------|-------------------|----------------------------|--------|---------------|
| | | Cochin | Madras | Visakhapatnam |
| 1. Fishing second-hand | 15 | 40 | 40 | 20 |
| 2. Engine driver | 15 | 40 | 40 | 20 |
| 3. Boatbuilding foreman | 15 | 20 | — | — |
| 4. Shore mechanics | 12 | 20 | 20 | — |
| 5. Gear technicians | 9 | 20 | 20 | — |
| 6. Radio telephone operators | 9 | 15 | 15 | — |
| 7. Teachers training | 6 | 10 | — | — |

A limited number of places is allotted to foreign candidates.

The institute provides, through arrangement with other projects under the Government of India, as well as in its own vessels and workshop, the requisite practical training for those who have completed institutional training to sit for Fishing Second-Hand and Engine Driver Competency examinations. Once qualified at these examinations, a further term of practical and *ad hoc* institutional training is provided for them to qualify as skippers and engineers of fishing vessels. In order to meet periodic shortage of certificated personnel, crash programmes of training are arranged for ex-naval personnel as well as mechanical engineering diploma holders.

11.2.2.3 Marine Fishermen Training Centres

Fishermen Training Centres are set up by the States for the training of fishermen in the operation of small mechanised fishing boats. There are at present 30 such training centres — 4 in Orissa, 2 in Gujarat, 4 each in Maharashtra and Karnataka, 5 in Kerala, 6 in Tamil Nadu, 2 in Andhra Pradesh and one each in the Union Territories of Lakshadweep, Goa and Andaman and Nicobar Islands.

The training given at these centres includes basic lessons in navigation, engines, gear construction and maintenance and different aspects of fishing.

The duration of training varies from state to state. The total intake capacity of the 30 training centres is about 1,000 trainees at a time. Candidates of age between 17 and 30 years and bona fide fishermen with at least five years' experience in fishing are admitted to the course.

After successful completion of the training, the trainees in groups of four and five are assisted to acquire small mechanised boats through loan and subsidy arrangements so as to afford them an opportunity for self-employment. About 10,000 persons have so far been trained at these training centres.

11.2.3 Others

11.2.3.1 College of Fisheries, Mangalore

The University of Agricultural Sciences, Karnataka, established the country's first college of fisheries at Mangalore in 1969.

This institute offers a four-year bachelor's degree programme in fishery science (B.F.Sc.), a 2-year master's degree programme in fishery science (M.F.Sc.), and a 3-year doctorate (Ph.D.) programme. The master's degree programme is in industrial fishery technology and fish production and management, while the Ph.D. programme is in fishery biology, aquaculture, aquatic biology, fishery oceanography and fish processing technology.

The entry qualification for the B.F.Sc. programme is a pass in the pre-university course (science) or its equivalent. The intake capacity is 40 students per year, with 33% set apart, at the disposal of the Indian Council of Agricultural Research, for allotment to other states and countries. Up to 15 students are admitted for each of the two M.F.Sc. programmes, while generally about 2 are admitted for the Ph.D. programme in each subject.

Besides the regular courses, the college periodically conducts short-term training programmes on various aspects of fishery science for the benefit of technical personnel of the Karnataka Department of Fisheries. Further, a 3-month fish processing technicians' course is periodically organised for the benefit of technicians employed in the fish processing industry, as and when requested by the Marine Products Export Development Authority.

In addition to professional and extension education in fisheries, the college also conducts extensive research on certain aspects of fishery science.

11.2.3.2 University of Cochin, Department of Industrial Fisheries

In 1977, the University of Cochin started a post-graduate course leading to the M.Sc. degree in Industrial Fisheries.

This 4-semester course has an intake capacity of 15 students per batch. The syllabus includes fisheries resources, fishing craft and gear technology, fish processing technology, fisheries economics and fisheries management.

12. INDUSTRY ORGANISATIONS

12.1 Fisheries corporations

With a view to providing the flexibility necessary for undertaking activities of a promotional nature, it was decided at the end of the Third Plan to establish fisheries corporations.

Accordingly the Central Fisheries Corporation was established in 1965 at Calcutta. State Fisheries Corporations were established in practically all the maritime states and in some inland states.

The corporations in inland states are recent developments, most of them being fish seed corporations. The Assam Fisheries Corporation, however, concentrates on *Bheel* development.

The fisheries corporations in marine states mostly concentrate on marine fisheries, undertaking activities such as deep sea fishing, processing, marketing, boatbuilding, net-making, ice making, etc.

The corporations are registered under the Companies Act. The organisational set-up of a corporation consists of a Chairman, Board of Directors, a Managing Director and executive officers. The Managing Director is the principal executive officer.

The Central Fisheries Corporation, Orissa Fisheries Corporation and the Maharashtra Fisheries Corporation are under liquidation although the last mentioned was revived for a while. In Orissa, a new corporation, viz., Orissa Maritime and Chilka Area Development Corporation, has been formed in place of the former Orissa Fisheries Corporation ; in Kerala, a Kerala Fishermen Welfare Corporation and a Kerala Inland Fisheries Corporation have been established in addition to the earlier Kerala Fisheries Corporation ; in Gujarat, Gujarat Agro-Marine Products, a subsidiary of the Gujarat Agro Industries Corporation, has taken the place of a fisheries corporation.

The financial performance of most corporations has been disappointing.

12.2 Fisheries cooperatives

The fisheries cooperative system in the country was organised with a view to providing assistance to the actual producers, the fishermen. Fisheries cooperatives are societies governed by a separate set of rules to channel government assistance on the basis of principles of self-help and management.

The fisheries cooperative structure in India is broadly three-tiered. It consists of a primary cooperative for a village or group of villages; a district or regional federation; and a state-level apex body constituted as a cooperative federation.

The primary fishery cooperative is expected to function as a multi-purpose agency providing credit, supplies (including domestic necessities), elementary guidance and supervision of the utilisation of loans, assembly of the fish-catch and its transportation to marketing centres. Member education and extension programmes are supplementary functions expected to be undertaken by the primary society in collaboration with other concerned agencies. In practice, however, primary fisheries cooperatives are mainly engaged in the provision of loans to the member fishermen. Some cooperatives have organised the provision of supplies and only a very few societies are engaged in activities such as construction of fishing boats and processing.

The regional federation is the district-level organisation which is expected to act as a useful and conveniently located intermediate agency between the apex body and the primary cooperative. It is expected to have an important role in marketing and, for that purpose, is located in the larger towns. Most of the other functions of the federation are similar to those of the primary cooperative but on a larger scale and catering to a wider area in providing assistance to the member-primary cooperatives.

The apex federation is the state-level organisation and is expected to provide support to the primary and district-level cooperatives. Through its location, size, capacity to command resources of men, material and market, it is expected to provide leadership to the entire movement.

In 1977-78, 72 fisheries federations had annual sales of Rs. 66.8 million excluding Rs. 3.9 million worth of exports. The eight apex societies in Andhra, Gujarat, Maharashtra, Kerala, Goa, Bihar, Pondicherry, and Andaman and Nicobar Islands handled business worth Rs. 47.1 million.

The overall performance of fisheries cooperatives has been poor and insufficient to make any significant impact on the lives of fisherfolk. Many of the cooperatives are operating at a loss and a large number are dormant. Their membership, share capital base and turnover are also often too weak and inadequate for viable operations. An indication of the status and performance of primary fisheries cooperative societies during 1976-77 is given in Tables 12.2.1 and 12.2.2.

Table 12.2.1

Situation of primary fisheries cooperative societies 1977/78

| Number | Membership | Amount in Rs. million | |
|--------|------------|-----------------------|---|
| | | Share Capital | Turn over (fish and fishing requisites) |
| 5251 | 574,685 | 36.2 | 94.3 |

Table 12.2.2

Performance of primary fisheries cooperatives in the maritime states, 1976/77

| State/Union Territory | No. of primary cooperatives | Societies showing profit | Societies showing loss | Societies with no profit, no loss | Percentage of societies showing profit |
|-----------------------|-----------------------------|--------------------------|------------------------|-----------------------------------|--|
| Andhra Pradesh | 1,169 | 569 | 444 | 156 | 49 |
| Gujarat | 138 | 55 | 33 | 50 | 40 |
| Kerala | 748 | 24 | 716 | 8 | 3 |
| Maharashtra | 530 | 247 | 212 | 71 | 47 |
| Karnataka | 148 | 57 | 91 | — | 39 |
| Orissa | 190 | 63 | 52 | 75 | 33 |
| Tamil Nadu | 500 | 87 | 409 | 4 | 17 |
| West Bengal | 672 | 228 | 215 | 229 | 34 |
| Goa, Daman & Diu | 14 | 8 | 6 | — | 57 |
| Pondicherry | 32 | 5 | 27 | — | 16 |
| Lakshadweep | 2 | — | — | 2 | — |
| A & N Islands | 10 | 1 | 9 | — | 10 |
| | 4,153 | 1,345 | 2,214 | 595 | 32 |

All state governments have full-fledged departments of cooperation. A separate wing of the Department of Cooperation works in several fisheries departments.

Cooperative banks provide credit, while fisheries departments provide share capital, managerial assistance, subsidies and loans for various approved activities, besides loaning the services of departmental officers to undertake activities on behalf of cooperative societies.

The Agricultural Refinance and Development Corporation (ARDC) undertakes various integrated projects through cooperatives and cooperative banks, the necessary guarantee for the amounts advanced being given in the state governments.

There are two other agencies that have a place in the cooperative set-up : the National Development Corporation (NCDC) and the National Cooperative Union of India (NCUI).

NCDC has been promoting the development of fishery cooperatives since 1974. It provides financial assistance to State Governments for contributing to the share capital of societies to enable the latter to expand their marketing, supply and distribution activities. Assistance is also made available for the purchase of traditional and mechanised boats, engines, transport vehicles, setting up of processing units, cold storages and ice plants, construction of godowns, fish curing

yards, boatbuilding yards; establishment of service and repair centres; establishment of technical and promotional cells; preparation of project reports for the establishment of processing units; undertaking of feasibility studies; specialised training of technical and managerial personnel of fishery cooperatives. Up to 31 March, 1981, the NCDC had sanctioned financial assistance of Rs. 77.4 million and the Government of India had provided Rs. 13.6 million under a central sector scheme to various fishery cooperatives.

NCUI is a body which is essentially intended for education of member fishery cooperatives and functionaries. With the aid of a sum of Rs. 2.7 million provided by NCDC, this body is implementing a three-year educational scheme since 1977/78 at nine locations, viz., Kozhikode, Tuticorin, Pondicherry, Contai, Berhampur, Kuluba, Kakinada, Mangalore and Valsad.

13. GOVERNMENT POLICY

Government policy in terms of objectives and strategy has been indicated as follows in the Sixth Five-Year Plan (1980/81-1984/85) document.

The objectives are :

- significant step-up in the rate of growth of the economy, the promotion of efficiency in the case of resources and improved productivity;
- strengthening the impulses of modernisation for the achievement of economic and technological self-reliance;
- progressive reduction in the incidence of poverty and unemployment;
- speedy development of indigenous sources of energy, with proper emphasis on conservation and efficiency in energy use;
- improving the quality of life of the people in general with special reference to the economically and socially handicapped population through a minimum needs programme whose coverage is so designed as to ensure that all parts of the country attain within a prescribed period nationally accepted standards;
- strengthening the redistributable bias of the public policies in favour of the poor, contributing to a reduction in inequalities of income and wealth;
- progressive reduction in regional inequalities in the pace of development and in the diffusion of technological benefits;
- promoting policies for controlling the growth of population through voluntary acceptance of the small family norm ;
- bringing about harmony between the short and the long term goals of development by promoting the protection and improvement of ecological and environmental assets; and
- promoting the active involvement of all sections of the people in the process of development through appropriate education, communication and institutional strategies.

The strategy adopted in the Sixth Plan consists essentially in moving simultaneously to strengthen the infrastructure for both agriculture and industry so as to create conditions for an accelerated growth in investment, output and exports and to provide, through special programmes designed for the purpose, increased opportunities for employment, specially in rural areas and the unorganised sector and meet the minimum basic needs of the people. Stress is laid on dealing with inter-related problems through a systems approach rather than in separate compartments; on greater management efficiency and intensive monitoring in all sectors and active involvement of the people in formulating specific schemes for the development of the local level and in securing their speedy and effective implementation. The attack on the problem of poverty is most effective only in the conditions of an expanding economy. Since growth by itself may not, however,

suffice, other programmes and policies will need to be adopted with the specific aim of improving the living conditions of the masses and to bring about a reduction in inequalities of income and wealth. The scheme of the Sixth Plan outlays provides for specific allocations for such programmes.

In the fisheries sector, during the Sixth Five-Year Plan period, the main thrust in marine fisheries will be to increase production through fish culture, deep-sea fishing with special reference to management of the Exclusive Economic Zone and diversification of fishing with emphasis on conservation of heavily exploited marine fishery resources on the one hand and the exploitation of new resources on the other.

On the deep-sea fishing front, one of the main limiting factors had been the problems in respect of arrangements for financing and acquisition of vessels. Soft term financing through the Shipping Development Fund Committee has been revived during the Sixth Plan period.

The introduction of mechanised boats will be on a selective basis; while they will be introduced freely in areas with a low density of fishing effort, they will be restricted in areas already having a large fishing fleet. Efforts will be made to diversify fishing methods by techniques such as purse-seining, longlining, squid-jigging, etc., to tap resources which are at present not being fully harvested.

Fiscal and administrative measures are to be taken to encourage fishermen cooperatives and small entrepreneurs to enter deep-sea fishing. The acquisition and operation of fishery vessels is being monitored with a view to removing various constraints and bottlenecks.

Protecting and promoting the interests of small fishermen by demarcating fishing zones and by developmental measures is one of the main planks of fisheries policy.

Since increase in marine fish production will be mainly from unconventional varieties for which presently there is little market demand, it has been proposed that IPF should be reorganised as a fish processing and marketing project.

EFP and CIFNET are to be revamped to improve the quality of survey as well as training. The activities of PISFH are to be enlarged to cover survey, design and preparation of project proposals for large brackishwater farms in addition to its present functions relating to fishing harbours.

Besides completing fishing harbours under construction, additional fishing harbours will be taken up at major and minor ports. A new programme during the Sixth Plan will be provision of landing and berthing facilities even for non-mechanised boats.

Since lack of adequate production of fish seed is one of the main constraints in inland fisheries, a national programme for 'fish seed' development has been proposed.

It has been proposed that a number of pilot projects relating to reservoir fisheries be undertaken.

The inland fisheries projects in West Bengal, Orissa, Madhya Pradesh, Uttar Pradesh and Bihar and the World Bank-assisted integrated marine fisheries projects in Gujarat and Andhra Pradesh will be implemented during the Plan period besides smaller projects with bilateral assistance.

14. DEVELOPMENT PLANS

Planned development of fisheries commenced from the first Five-Year Plan, which started in 1951-52. Outlays and expenditure for fisheries development in the respective plan periods is shown in Appendix 14.1.

Programmes and schemes drawn up for the Sixth Five-Year Plan (1980/81-1984/85) are a continuation of the developmental activities in the various fields with special emphasis on sectors to which adequate attention had not been given.

The various plan schemes are formulated after a critical review of the progress achieved by programmes during the previous years and the difficulties/bottlenecks encountered in implementation. Each of the plan schemes includes objectives, physical programmes, targets and other objectives as may be relevant to its subject with due regard to the national objectives of self-reliance, export promotion, more equitable distribution of income and wealth, generation of more employment and improvement in the social and economic conditions of the weaker sections of society.

Based on functional pattern and administrative nature, the various fisheries plans are classified under three categories-central sector schemes, centrally sponsored schemes and state sector schemes.

The central sector schemes cover activities which are either the direct responsibility of the Central Government or in which the Centre has direct promotional interest.

The centrally sponsored schemes are schemes sanctioned by the Central Government to assist the states in key areas where central assistance becomes necessary. These schemes are administered by state governments.

The state sector schemes are formulated, financed and administered by the states themselves.

A list of central and centrally sponsored schemes, along with outlays in the Sixth Plan is given in Appendix 14.2. Appendix 14.3 shows the statewise outlays for fisheries. An analysis of the state plan outlay by broad heads of development is given in Appendix 14.4.

India is actively associated with international endeavours in fostering cooperation for fisheries development. She is the recipient of international assistance for fisheries under multilateral and bilateral programmes; and of her own also gives cooperation and assistance in fields where it can be beneficial to other countries.

Among past assistance programmes, TCM Aid, Norwegian project assistance and UNDP/SF assistance are important. Norway continues assistance by way of commodity aid, assistance for fishing vessel construction, strengthening of facilities at Goa Shipyard and a small area development project at Balasore (Orissa). Holland, Denmark, and Japan provided aid for the acquisition of exploratory and training vessels. Denmark, Sweden and the United Kingdom have shown interest in undertaking area development projects in Karnataka, Andhra Pradesh and Orissa. A Danish proposal for an area development project at Tadri (Karnataka) is nearing finalisation.

India has also obtained World Bank assistance for *two* integrated marine fisheries projects, one in Gujarat and the other in Andhra Pradesh and for an inland fisheries project covering West Bengal, Bihar, Orissa, Uttar Pradesh and Madhya Pradesh.

A list of aid projects is given in Appendix 14.5.

Under the Indian Technical and Economic Cooperation (ITEC) programme, assistance is extended to other countries and training facilities are provided at various fisheries training institutes/centres. India also subscribes to the concept of Technical Cooperation among Developing Countries (TCDC).

15. BIBLIOGRAPHY

- B. N. Chopra. 1951 Handbook of Indian Fisheries, prepared for the Third Meeting of the *Indo-Pacific Fisheries Council, Madras*, February 1951.
- 1970 Proceedings of the Symposium on Development of Deep-Sea Fishing sponsored by Govt. of India, *Ministry of Food and Agriculture (Department of Agriculture)*, New Delhi.
- 1971 Evaluation of the Programme of Mechanisation of Fishing Boats. State Reports. *Programme Evaluation Organisation, Planning Commission, Government of India*.
- 1973 Proceedings of the Symposium on Living Resources of the Seas around India. Special publication of the *Central Marine Fisheries Research Institute, Cochin 11*.
- E. G. Silas, S. K. Dharmarajan and K. Rangarajan. 1976 Exploited Marine Fishery Resources of India : A synoptic survey with comments on potential resources. *Cent. Mar. Fish Res. Instt. Bulletin 27*.
- Anon. 1976 Report of the National Commission on Agriculture, Part VIII : Fisheries. *Government of India, Ministry of Agriculture and irrigation, New Delhi*.
- R. S. Saksena, T. A. Mammen, M. Devidas Menon & N. P. Bhakta, 1976 Report of the Technical Team on Development of Fisheries in Andaman & Nicobar Islands.
- P. C. George, B. T. Antony Raja and K. C. George. 1977 Fishery Resources of the Indian Economic Zone. Souvenir issued on the occasion of the silver jubilee celebrations of the *Integrated Fisheries Project, Cochin, India, October 1977*.
- 1978 Report of the Working Group on Fisheries for Formulation of Five-Year Plan 1978-83. *Ministry of Agriculture and Irrigation (Department of Agriculture, New Delhi)*.
- T. A. Mammen, D.A. S. Gnanadoss, George Varghese & P. K. Eapen, 1978 Report of the Working Group on Development of Fisheries in the Lakshadweep Islands.
- Anon. Summary of Report on Cruise of M/T Muraena in the North-West Coast of India. *Sea Fisheries Institute, Gdynia, Poland; Govt. of India, Ministry of Agriculture* (in press).
- Anon. 1980 India, Oceanographic Investigations along the South-West Coast of India (1976-78). A report prepared for Pelagic Fishery Investigations on the South-west Coast, Phase II-Project. *FAO of the UN, Rome FI: DP/IND/75/038, Field Document 5*.
- Anon. 1980 Proceedings of the First National Symposium on Shrimp Farming, Bombay, 16-18 August, 1978. *Marine Products Export Development Authority, Cochin*.

- E. G. Silas, K. Alagiriswamy. 1980 Country Status Report on India, Indo-Pacific Fisheries Council, 19th Session, Section III Symposium on Development and Management of Small-Scale Fisheries, pp. 19-1 36.
- Anon. 1980 A Note on Indian Sea Food Industry- *The role of MPEDA in its development. Mimeo.*
- 1981 Sixth Five-Year Plan — 1980-85. *Planning Commission, New Delhi.*
- 1981 Proceedings of the Seminar on the role of Small-Scale Fisheries and Coastal Aquaculture, *Central Marine Fisheries Research Institute, Cochin 682018.*
- E. H. Nichols. 1981 Possibilities of Technical Cooperation between Developing Countries (T.C.D.C.) in Fisheries. *Bay of Bengal Programme Development of Small-Scale Fisheries.*
- 1981 Marine Products Export Review 1980-81. *Marine Products Export Development Authority, Cochin. Mimeo.*
- 1981 Statistics of Marine Exports 1979. *Ibid.*
- K. M. Joseph. 1981 Report on the Marine Fishery Resources of India, Part I : Resources of the West Coast of India. *M. Visveswaraya Industrial Research and Development Centre. MSS.*
- Anon. 1981 Master Plan for Development of Fishery Harbours. *Ibid.*
- 1981 Handbook of Fisheries Statistics, *Department of Agriculture, New Delhi.*
- 1981 Annual Report 1980-81, Department of Agriculture, *Ministry of Agriculture and irrigation, New Delhi.*
- 1981 Marine Fish Marketing in India Vol. II-VIII. *Centre for Management in Agriculture, Indian Institute of Management, Ahmedabad. Mimeo.*

APPENDIX -1.1

MAP OF INDIA



Appendix 1.2

Country Data

| | | | |
|-----------------------------------|-------------------------------------|---|---------------------------|
| 1. Size | Area : | 3,287,782 km ² (provisional as on 1st July 1971) | |
| | Coastline : | 7,517 km | |
| | Continental shelf: | 452,060 km ² | |
| 2. Population | | 1971 census | 1981 census (provisional) |
| | Total : | 548 million | 684 million |
| | Urban : | 19.9% | N.A. |
| | Rural : | 80.1% | N.A. |
| | Density : (per km ²) | 177 | 221 |
| | Estimated population : | 601 million (1975) | 727 million (1985) |
| | Birth rate : | 4.1% | N.A. |
| | Death rate : | 1.8% | N.A. |
| | Growth rate : (Decennial) (1971-81) | 24.75% | |
| | Life expectancy : (1960-70) | | |
| | Males | 46.4 years | |
| | Females : | 44.7 | |
| 3. Education (1981 census) | Literacy rate : Total | 36.17% | |
| | Males | 46.74% | |
| | Females | 24.88% | |

School Enrolment (provisional figures)

| Level | Age Group | % of total population of the age group |
|---|-----------|--|
| Primary school (Classes I-V) | 6-11 | 84.01 |
| Middle School (Classes VI-VII) | 11-14 | 39.07 |
| Secondary School (Classes VIII and above) | 14-17 | 16.09 |
| University/College | 17-23 | 4.41 |

| | |
|-------------------------------|--|
| 4. Health (1978/79) | Population per doctor: 3,700 |
| | Population per hospital bed : 1,200 |
| 5. Nutrition (1970/71) | Calorie intake as % of requirement: 77.8 |
| | Per capita protein intake : 40-52 gm/day |

6. Employment (1971) Population by categories of workers

| Category | Percentage of total population | Percentage of total workers |
|--|-----------------------------------|--------------------------------|
| Total workers | 32.9 | 100.0 |
| (i) Cultivators | 14.3 | 43.3 |
| (ii) Agricultural labourers | 8.6 | 26.3 |
| (iii) Livestock, forestry, fishing, etc. | 0.8 | 2.4 |
| (iv) Mining, manufacturing and construction | 3.7 | 11.2 |
| (v) Trade, commerce, transport and communication | 2.6 | 8.0 |
| (vi) Other services | 2.9 | 8.8 |

7. Net National Product (1979/80 Quick estimates)

| | |
|--|--------|
| NNP at 1970/71 prices (Rs. million) | 443280 |
| NNP at 1970/71 prices per capita (Rs.) | 667.8 |
| NNP at factor cost at current prices (Rs. million) | 901730 |
| NNP at current prices per capita (Rs.) | 1378.8 |

8. Trade

Exports (1978/79)

| Commodities | Percentage of total exports |
|--|--------------------------------|
| (1) | (2) |
| Pearls, precious and semi-precious stones, worked, unworked | 12.4 |
| Engineering goods | 12.2 |
| Cotton piece goods and cotton apparel .. | 9.5 |
| Tea | 5.9 |
| Leather and leather manufactures . . | 5.6 |
| Woollen carpets etc. | 4.1 |
| Fish and fish preparations | 4.0 |
| Jute | 2.9 |
| Chemicals and allied products | 2.6 |
| Coffee | 2.5 |
| Sugar | 2.3 |
| Oil cakes | 2.0 |
| Iron and Steel | 2.0 |
| Tobacco | 1.9 |
| Others | 30.1 |

Imports (1978/79)

| Commodities | Percentage of total imports |
|---|--------------------------------|
| Petroleum | 18.4 |
| Machinery | 14.1 |
| Vegetable oil | 7.9 |
| Iron and Steel | 6.9 |
| Fertilizers | 5.5 |
| Transport equipment | 4.0 |
| Chemical elements and compounds | 3.3 |
| Synthetic and regenerated fibres | 2.9 |
| Copper | 1.5 |
| Newsprint | 1.2 |
| Medicinal and pharmaceutical products | 1.2 |
| Others | 33.1 |

Balance of Trade (1974-79)

Million Rs.

| | 1974-75 | 1975-76 | 1976-77 | 1977-78 | 1978-79 |
|--------------------------------|---------------|---------------|--------------|--------------|---------------|
| Imports | 45188 | 52652 | 50738 | 60253 | 68032 |
| Exports (including re-exports) | 33288 | 40423 | 51423 | 54043 | 57252 |
| Balance | -11900 | -12229 | +685 | -6210 | -10780 |

9. Prices

Consumer price index numbers of food items for agricultural labourers (base 1960/61=100)

| Year | Index |
|-----------|-------|
| 1974-75 | 413 |
| 1975-76 | 345 |
| 1976-77 | 324 |
| 1977-78 | 349 |
| 1978-79 | 340 |
| 1979-80 | 390 |
| 1980-81 | 448 |
| June 1981 | 470 |

Annual average indices of wholesale prices of fish, meat, food articles and all commodities (Base 1970/71 =100)

| Year | Fish | Meat | Food articles | All commodities |
|------------|-------|-------|---------------|-----------------|
| 1972 | 115.5 | 114.7 | 107.9 | 113.0 |
| 1973 | 133.8 | 142.2 | 128.6 | 131.6 |
| 1974 | 159.3 | 182.2 | 165.3 | 169.2 |
| 1975 | 157.8 | 202.5 | 170.8 | 175.8 |
| 1976 | 172.7 | 191.7 | 152.2 | 172.4 |
| 1977 | 192.3 | 215.9 | 170.8 | 185.4 |
| 1978 | 228.8 | 235.9 | 173.4 | 184.9 |
| 1979 | 252.7 | 255.6 | 181.4 | 206.0 |
| 1980 | 267.0 | 306.4 | 183.2 | 248.0 |

Source: Economic Adviser, Ministry of Industrial Development.

Appendix 3.1**STATEWISE DISTRIBUTION OF MECHANISED BOATS (1980)**

| State | Trawlers | Gill netters | Purse seiners | Dol-netters | Others | Total |
|--|------------------|--------------|---------------|-------------|--------|--------|
| West Bengal | — | 740 | — | — | — | 740 |
| Orissa | 350 | 119 | — | — | — | 469 |
| Andhra Pradesh | 580 | — | — | — | — | 580 |
| Tamil Nadu | 2,614 | 143 | — | — | — | 2,757 |
| Pondicherry | 160 | 3 | — | — | — | 163 |
| Kerala | 2,630 | 362 | 37 | — | 9 | 3,038 |
| Karnataka | 1,553 | 28 | 325 | — | 98 | 2,004 |
| Goa | 494 | 274 | 66 | — | 74 | 908 |
| Gujarat | 1,209 | 1,547 | — | 650 | 7 | 3,413 |
| Total (excluding Maharashtra, Andamans & Lakshadweep) | 9,590 | 3,216 | 428 | 650 | 188 | 14,072 |
| Andamans | Figures from : | | | | | 10 |
| Lakshadweep | Indian Fisheries | | | | | 213 |
| Maharashtra | 1947-77 | | | | | 4,718 |
| All India | | | | | | 19,013 |

Source: Marine Fisheries Information Service (August 1981)

Appendix 3.2

STATEWISE DISTRIBUTION OF NON-MECHANISED MARINE FISHING CRAFT IN INDIA 1980¹

| Type of boat | West Bengal | Orissa | Andhra Pradesh | Tamil Nadu | Pondicherry Karaikal Mahe & Yenam | Kerala | Karnataka | Goa Daman Diu | Gujarat | Total |
|-------------------|--------------|--------------|----------------|---------------|---|---------------|--------------|---------------------|--------------|-----------------|
| Plank-built boats | 3,972 | 3,262 | 11,359 | 8,957 | 83 | 4,376 | 1,747 | 1,108 | 3,040 | 37,904 |
| Dugout canoes | 89 | 186 | 1,781 | 2,210 | 72 | 10,415 | 4,454 | 1,397 | 1,080 | 21,684 |
| Kattumarams | — | 6,276 | 22,198 | 31,851 | 1,595 | 11,480 | 23 | 8 | — | 73,431 |
| Others | — | 4 | 675 | 325 | — | — | 718 | — | — | 1,722 |
| Total | 4,061 | 9,728 | 36,013 | 43,343 | 1,750 | 26,271 | 6,942 | 2,513 | 4,120 | 1,34,741 |

¹No figures for the state of Maharashtra are available. Figures refer to craft owned/shared by fishermen only.

Source: Marine Fisheries Information Service (August 1981).

Appendix 3.3

SALIENT FEATURES OF SOME IMPORTANT FISHING CRAFT TYPES

| Craft | Size (M) | Construction | Propulsion | Engine Horse Power | Crew No. | Operational area |
|-------------------|---------------------------------------|---|------------|---------------------------------------|----------|-------------------|
| Kattumaram | L: 5-10 | 2-5 logs of wood tied together into a raft | Manual | N.M. | 2-4 | Inshore |
| Dugout | L: 3.6-10 | Hollowing out a single log of wood | Manual | N.M. | 2.8 | Inshore |
| Plank built craft | L: 6-14 | Wooden planks stitched or nailed to a rigid frame | Manual | Some mechanised with 15-30 HP engines | 7-12 | Inshore |
| Pablo boat | L: 7-4 w: 2.1 D: 1.05 | Standard type of boat construction in wood | Mechanical | 10-20 | 3.4 | Inshore |
| Shrimp trawlers | L: 9.6-15 W: 2.2-3.5 D: 1.2-2.2 | | Mechanical | 20-100 | 4-6 | Inshore/off shore |
| Purse-seiners | L: 14.5 w: 3.5 D: 2.2 | | Mechanical | 105-120 | 18-22 | Inshore/offshore |
| Steel trawlers | L: 14-30 | Standard type of boat construction in steel | Mechanical | 90-400 | 6-16 | Offshore/deep sea |

L = Length; W = Width; D = Depth; N.M. = Non-mechanical.

Appendix 3.4

STATEWISE FIGURES OF MARINE FISHING GEARS IN INDIA 19801

| Items | West Bengal | Orissa | Andhra Pradesh | Tamil Nadu | Pondicherry, Karaikal, Mahe & Yenam | Kerala | Karnakata | Goa, Daman, Diu | Gujarat | Total |
|-----------------------------|-------------|--------|----------------|------------|-------------------------------------|--------|-----------|-----------------|---------|----------|
| <i>No. of fishing gears</i> | | | | | | | | | | |
| Trawl nets | — | — | 823 | 6,219 | 437 | 1,454 | 1,788 | 772 | 2,672 | 14,165 |
| Purse-seines | — | — | — | — | — | 9 | 188 | 41 | — | 238 |
| Drift/gillnets | 2,467 | 10,427 | 42,385 | 1,18,300 | 1,851 | 23,307 | 6,571 | 3,346 | 7,383 | 2,16,037 |
| Boat seines | — | 2,676 | 9,738 | 7,220 | 375 | 9,779 | 23 | 165 | — | 29,976 |
| Fixed bag nets | 6,200 | 2,778 | 14,617 | 1,842 | 152 | — | 941 | 430 | 21,857 | 48,817 |
| Hooks and lines | 869 | 15,265 | 10,752 | 22,111 | 720 | 2,949 | 1,507 | 127 | 2,376 | 56,676 |
| Rampans | — | — | — | — | — | — | 86 | 101 | — | 1 8 7 |
| Shore seines | 436 | 2,893 | 3,042 | 4,549 | 84 | 2,926 | 3,924 | 987 | — | 18,841 |
| Traps | 61 | 515 | 130 | 8,919 | 9 | 2,239 | — | — | 86,952 | 98,825 |
| Scoop nets | 345 | 37 | 2,925 | 1,040 | 362 | 1,371 | — | — | — | 6,080 |
| Others | 2,433 | 5,201 | 37,199 | 6,339 | 120 | 2,761 | 10,925 | 2,813 | 28,013 | 95,804 |

¹ No figures for the state of Maharashtra are available. Figures refer to gear owned/shared by fishermen only.

Source: Marine Fisheries information Service (August 1981).

Appendix 3.5

COMMON CRAFT-GEAR COMBINATIONS

| Boat Type | Fishing gear | Area of Operation |
|--------------------------------------|---|---------------------------|
| Satpati type boat | Drift nets, fixed nets, bag nets, seines, drift nets, drag nets | Gujarat & Maharashtra |
| Satpati type boat (mechanised) | Trawl nets, longlines | |
| Plank-built outrigger boat | Shore seines, boat seines, gillnets, drag nets | Goa and Karnataka |
| Dug out boat | Cast nets, boat seines | Mostly West Coast |
| Kattumarams and Tuticorin type boats | Drift nets, lines, gillnets, boat seines | Mostly East Coast |
| Masula boat | Drift nets, drag nets | Andhra Pradesh and Orissa |
| Chandi-type boat | Bag nets, seines, drift nets | Orissa |
| Pablo boat (mechanised) | Longlines, gillnets, drift nets | On both coasts |
| Mechanised vessels | Shrimp trawl | On both coasts |

Appendix 4.1

FISHING HARBOURS AT MAJOR PORTS UNDER CONSTRUCTION/COMPLETED (1981)

| Sl. No. | Name of Harbour | Sanctioned Cost (Rs. in million) | Design | | Capacity |
|---------|--|----------------------------------|------------------|------------|-------------------------|
| | | | Deep Sea Vessels | Sea (Nos.) | Mechanised Boats (Nos.) |
| 1. | Madras | 66.8 | 50 | | 500 |
| 2. | Cochin | 40.9 | 57 | | 450 |
| 3. | (i) Roychowk | 32.3 | 15 | | |
| | (ii) Shore complex at Roychowk fishing harbour | 7.2 | — | | — |
| 4. | (i) Visakhapatnam (Stage 1)** | 44.1 | 35 | | 150 |
| | (ii) Visakhapatnam (Stage II) | 57.9 | 15 (addl.) | | 150 (addl.) |
| 5. | Sassoon Dock (Bombay) | 40.6 | — | | 700 |

All the above harbours in varying stages of construction are under use except Roychowk.

**Completed.

Appendix 4.2

FISHING HARBOURS AT MINOR PORTS UNDER CONSTRUCTION/COMPLETED (1981)

A. Fishing harbours costing more than Rs. 10 million

| Sl. No. | Name of Harbour | Amount Sanctioned (Rs. in million) | Designed | | Capacity |
|--------------------------|---------------------------|------------------------------------|------------------|------------|-------------------------|
| | | | Deep Sea Vessels | Sea (Nos.) | Mechanised Boats (Nos.) |
| I. Andhra Pradesh | | | | | |
| | 1. Kakinada | 46.0 | 15 | | 200 |
| | 2. Bavanapadu | 15.0 | — | | 200 |
| II. Gujarat | | | | | |
| | 1. Veraval | 90.0 | 20 | | 300 |
| | 2. Mangrol | 20.0 | — | | 210 |
| | 3. Porbunder | 15.0 | — | | 140 |
| III. Karnataka | | | | | |
| | 1. Malpe | 42.6 | 20 | | 300 |
| IV. Kerala | | | | | |
| | 1. Vizhinjam* (1st Stage) | 17.3 | 85 | | 210 |
| V. Maharashtra | | | | | |
| | 1. Ratnagiri | 34.4 | 40 | | 400 |
| VI. Tamil Nadu | | | | | |
| | 1. Tuticorin* | 21.0 | 65 | | 300 |

Appendix 4.2 (contd.)

B. Fishing harbours costing more than Rs. one million¹

| Sl. No. | Name of harbour | Amount sanctioned (Rs. in million) | Designed capacity | |
|--|---------------------|------------------------------------|-------------------------|-------------------------|
| | | | Deep Sea vessels (Nos.) | Mechanised boats (Nos.) |
| I. Andhra Pradesh | | | | |
| 1. | Nizampatnam | 7.7 | — | 100 |
| II. Gujarat | | | | |
| 1. | Jaffrabad* | 1.2 | — | 32 |
| 2. | Vansi-Porsi | 1.6 | — | 45 |
| 3. | Kosamba | 1.3 | — | 425 |
| III. Karnataka | | | | |
| 1. | Honnavar | 4.6 | — | 120 |
| 2. | Karwar (1st Stage)* | 3.0 | 20 | 200 |
| 3. | Mangalore | 4.3 | — | 230 |
| IV. Kerala | | | | |
| 1. | Paliapatnam* | 1.3 | — | 54 |
| 2. | Mopla Bay* | 3.0 | — | 166 |
| 3. | Kasargode* | 1.3 | — | 100 |
| V. Maharashtra | | | | |
| 1. | Karanja | 1.1 | — | 30 |
| VI. Orissa | | | | |
| 1. | Dhamra* | 6.9 | 15 | 35 |
| 2. | Chandipur | 1.5 | — | 28 |
| VII. Tamil Nadu | | | | |
| 1. | Mallipatnam* | 1.1 | — | 54 |
| 2. | Kodikkarai* | 1.4 | — | 54 |
| 3. | Cuddalore* | 1.2 | — | 54 |
| VIII. Andaman & Nicobar Islands | | | | |
| 1. | Phoenix Bay* | 6.7 | — | 47 |

¹ Works of less than Rs. 1 million not shown in this list.

Appendix 4.2 (contd.)

C. Small landing centres costing Rs. 0.5 million and above(completed)

| | | | | | Rs. in million |
|------------------------|-----------------|----|----|----|----------------|
| <i>I . Gujarat</i> | | | | | |
| | (i) Umersadi | . | . | .. | 0.51 |
| | (ii) Jaikhau | .. | .. | .. | 0.54 |
| <i>II. Karnataka</i> | | | | | |
| | (i) Bhatkal | .. | .. | .. | 0.56 |
| <i>III. Kerala</i> | | | | | |
| | (i) Ponnani | .. | .. | .. | 0.75 |
| <i>IV. Tamil Nadu</i> | | | | | |
| | (i) Rameshwaram | .. | .. | .. | 0.99 |
| <i>V. West Bengal</i> | | | | | |
| | (i) Namkhanna | .. | .. | .. | 0.70 |
| <i>VI. Lakshadweep</i> | | | | | |
| | (i) Kavaratti | .. | .. | .. | 1.10 |

(Works of less than Rs. 0.5 million not shown in the above list.)

* Completed.

Source: Ministry of Agriculture, Fisheries Division.

Appendix 4.3

PLAN-WISE OUTLAYS AND EXPENDITURE FOR FISHING HARBOURS AT MAJOR AND MINOR PORTS

| Plan periods | Major harbours | | Minor harbours | |
|--|----------------|-------------------------------------|----------------|-----------------------|
| | Outlay | Expenditure (Actuals) (Rs. million) | Outlay | Expenditure (Actuals) |
| Third Plan period | 0.5 | 1.15 | — | — |
| Three Annual Plans (I 966-67 to 1968-69) | 25.3 | 0.26 | 29.5 | 13.2 |
| Fourth Plan period | 135.0 | 16.1 | 60.0 | 51.7 |
| Fifth Plan period | 180.0 | 121.0 | 120.0 | 32.1 |
| <i>Annual Plans:</i> | | | | |
| (i) 1978-79 (Actuals) | 50.0 | 30.8 | 60.0 | 39.4 |
| (ii) 1979-80 (Actuals) | 55.0 | 30.6 | 25.3 | 8.1 |
| <i>Sixth Plan:</i> | | | | |
| (i) 1980-81 | 170.0 | - | 190.0 | — |
| (ii) 1981-82 (B.E.) | 40.0 | 35.0 | 24.5 | — |
| | 45.0 | — | 45.0 | — |

Source: Ministry of Agriculture, Fisheries Division.

Appendix 4.4

DEVELOPMENT OF REFRIGERATION FACILITIES FOR STORAGE AND DISTRIBUTION — PLAN-WISE

| Plan | Ice Plant | | Cold/frozen Storage | | Freezing Plant | |
|---------------------------------|------------------|------------------|---------------------|------------------|------------------|------------------|
| | Capacity (tonne) | Capacity (tonne) | Capacity (tonne) | Capacity (tonne) | Capacity (tonne) | Capacity (tonne) |
| Pre-plan | .. | .. | — | 42 | 0.75 | |
| First Five-Year Plan (1951-56) | .. | .. | 39.00 | 300 | 14.00 | |
| Second Five-Year Plan (1956-61) | . . | .. | 74.50 | 735 | 21 .00 | |
| Third Five-Year Plan (1961-66) | .. | .. | 170.75 | 686 | 20.50 | |
| Annual Plan (1966-67) | .. | .. | 10.50 | 20 | — | |
| Annual Plan (1967-68) | .. | .. | 19.00 | 126 | 9.00 | |
| Annual Plan (1968-69) | .. | .. | 88.50 | 494 | 14.50 | |
| Fourth Five-Year Plan (1969-74) | . . | .. | 162.00 | 956 | 52.50 | |
| Cumulative as on 31-3-1974 | .. | .. | 564.25 | 3263 | 132.25 | |
| Cumulative as on 1-12-1980 | .. | .. | 1915.75 | 35942.35* | 1486.13 | |

* Includes 4718 tonne frozen storage.

Appendix 4.5

STATEWISE DISTRIBUTION OF REFRIGERATION FACILITIES 1980

| States | Freezing | | Ice making | | Cold storage | |
|----------------|------------|-----------------|------------|-----------------|--------------|------------------|
| | Nos. | Capacity | Nos. | Capacity | Nos. | Capacity |
| 1 | 2 | 3 | 4 | 5 | 6 | 7 |
| Kerala | 117 | 533.80 | 56 | 643.75 | 141 | 11,547.85 |
| Karnataka | 29 | 112.84 | 15 | 212.00 | 31 | 2,612.00 |
| Tamil Nadu | 46 | 180.44 | 36 | 334.50 | 60 | 5,423.50 |
| Andhra Pradesh | 21 | 85.50 | 23 | 254.00 | 25 | 2,096.00 |
| Pondicherry | — | — | — | — | 1 | 5.00 |
| Lakshadweep | — | — | — | — | — | — |
| Maharashtra | 41 | 288.30 | 5 | 218.00 | 46 | 7,336.00 |
| Gujarat | 11 | 92.00 | 9 | 96.50 | 23 | 3,283.00 |
| Goa | 12 | 45.00 | 2 | 19.00 | 9 | 560.00 |
| Orissa | 14 | 52.00 | 5 | 48.00 | 15 | 1,150.00 |
| West Bengal | 31 | 96.25 | 5 | 90.00 | 27 | 1,929.00 |
| Total | 322 | 1,486.13 | 156 | 1,915.75 | 378 | 35,942.35 |

Source: MPEDA, Cochin.

Appendix 4.6**MANUFACTURE OF MARINE DIESEL ENGINES**

| Name of manufacturing firm | Make and horsepower of the engine | Total annual licensed capacity |
|--|-----------------------------------|--------------------------------|
| M/s. Premier Automobiles | "Meadows" 44 to 70 | 3000 |
| M/s. Ruston & Hornsby (India) Limited, Poona | "Ruston" 25 to 75 | 720 |
| M/s. Kirloskar Oil Engines Limited, Poona | "Kirloskar"/Man 3-440 | 600 |
| M/s. Kirloskar Cummins Limited, Poona | "Kirloskar Cummins" 130-800 | N.A. |
| M/s. Garden Reach Workshop Marine Engine Division, Ranchi | Man/800-18,000 | N.A. |
| Greeves Lombardini Aurangabad | "Lombardini" 5-10 | N.A. |
| VST Tillers and Tractors Bangalore | "Mitsubishi" | N.A. |
| M/s. Ashok Leyland Limited, Madras | "Leyland" 70-130 | N.A. |

APPENDIX – 5.1

MARINE FISH PRODUCTION IN INDIA
(IN MILLION TONNES)

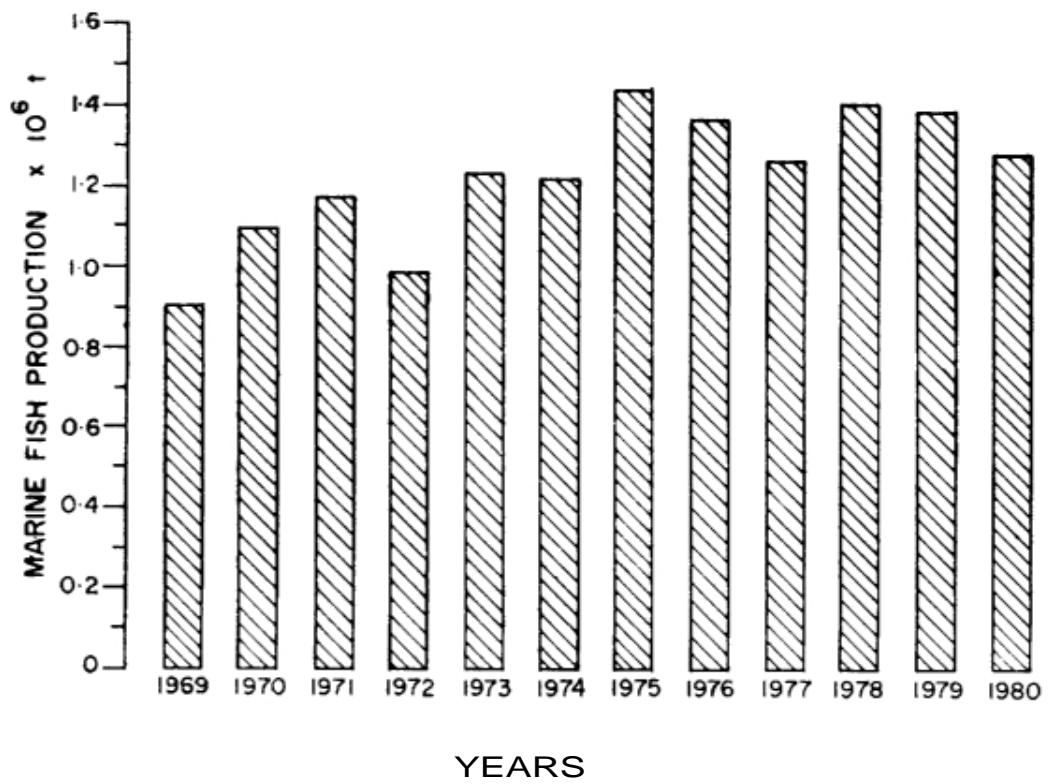

APPENDIX - 5 2

PERCENTAGE COMPOSITION OF MARINE FISH CATCH
BY THE TRADITIONAL AND MECHANISED SECTORS

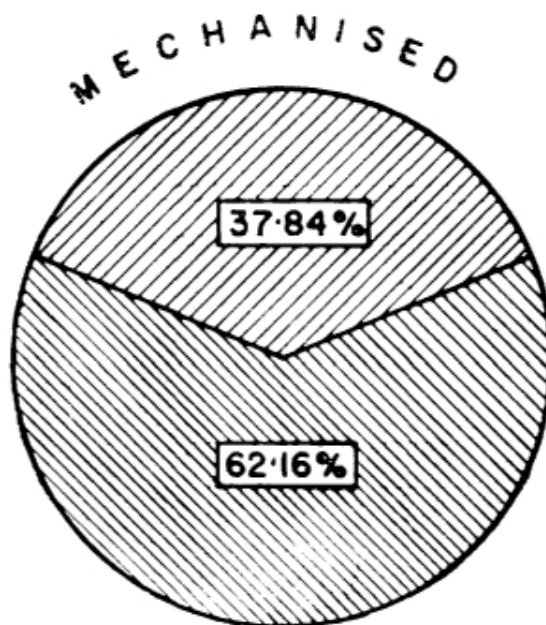

MARINE FISH PRODUCTION BY THE TRADITIONAL AND MECHANISED SECTORS IN THE MARITIME STATES

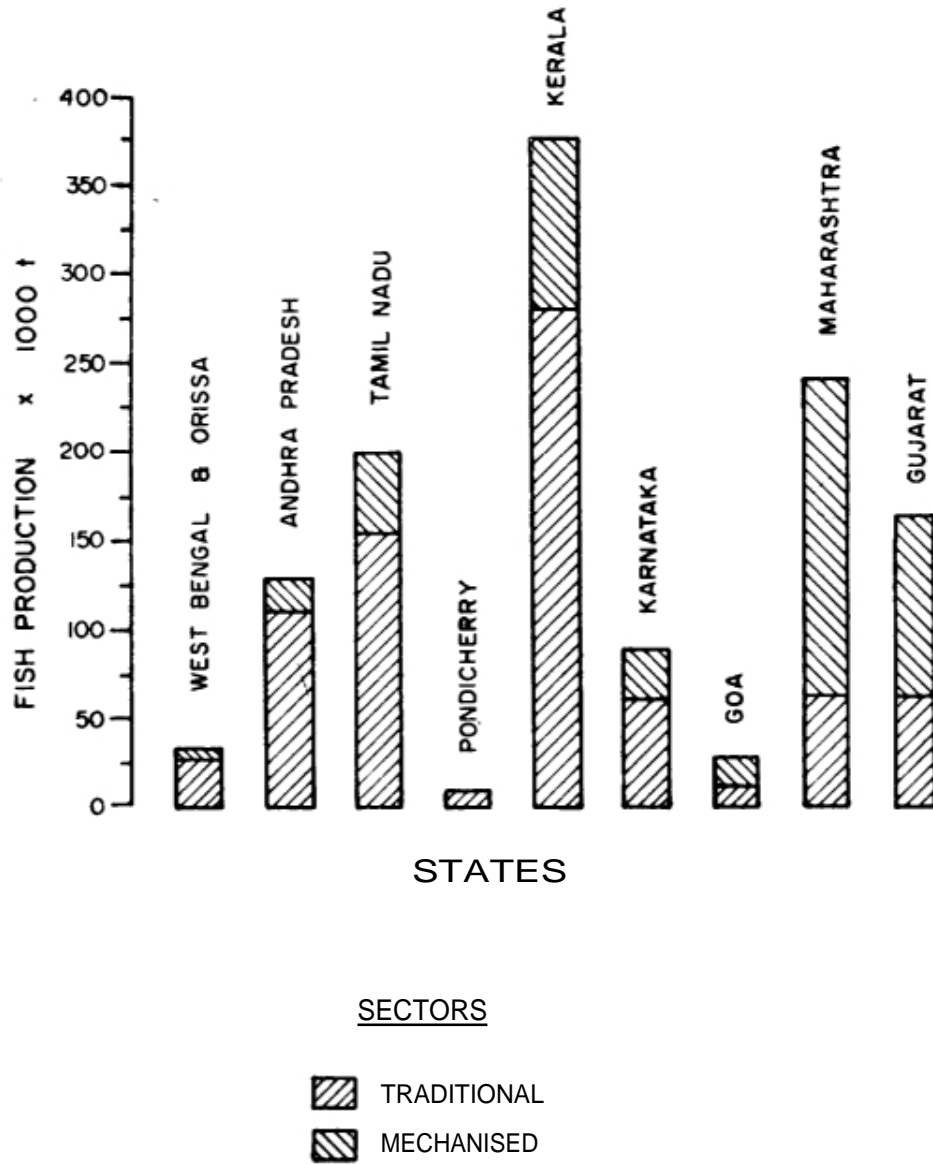

APPENDIX - 54

TRENDS IN FISH PRODUCTION BY THE TRADITIONAL
SECTOR IN THE MARITIME STATES DURING 1969- 1977

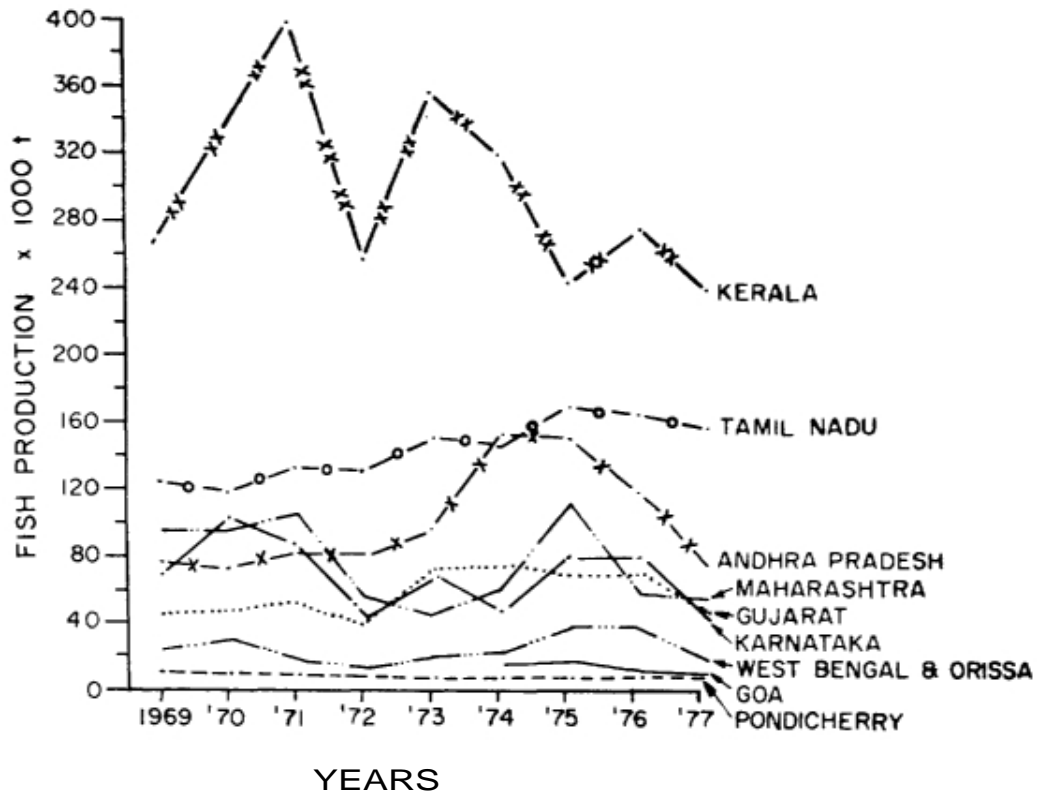

APPENDIX -5.5

TRENDS IN FISH PRODUCTION BY THE MECHANISED SECTOR
IN THE MARITIME STATES DURING 1969 -1977

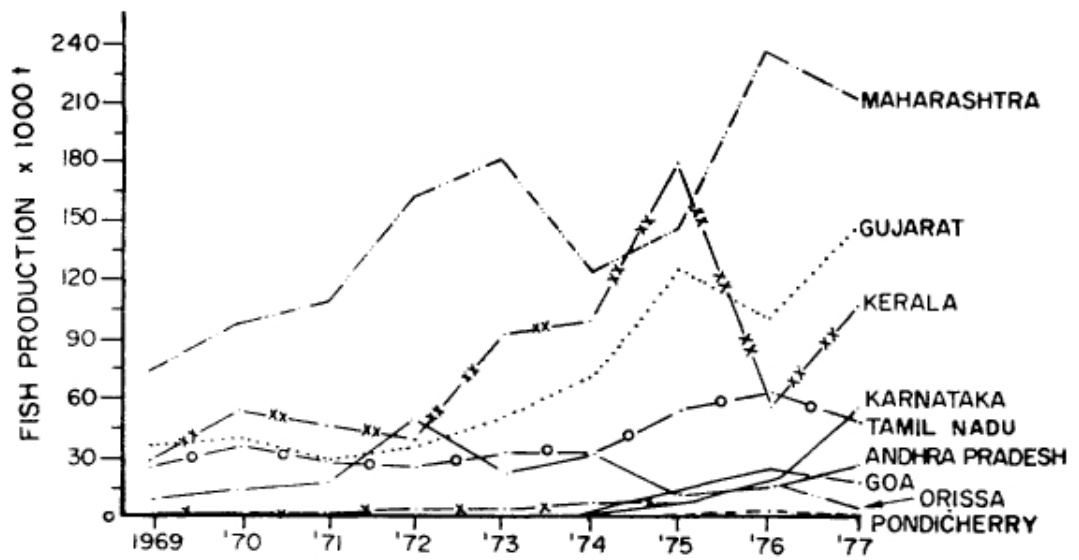

Appendix 5.6

COMPOSITION OF MARINE FISH LANDINGS IN INDIA DURING 1977 TO 1980

| S.No. | Name of fish | 1977 | 1978 (tonnes) | 1979 | 1980 |
|-------|-------------------------------------|-----------|------------------|-----------|-----------|
| 1. | Elasmobranchs .. | 62,216 | 61,621 | 52,843 | 57,862 |
| 2. | Eels .. | 12,997 | 8,781 | 7,155 | 12,082 |
| 3. | Catfishes .. | 53,504 | 39,231 | 48,817 | 43,745 |
| 4. | <i>Chirocentrus</i> .. | 11,909 | 10,990 | 10,274 | 12,805 |
| 5. | (a) Oil sardine .. | 150,130 | 168,078 | 153,971 | 15,744 |
| | (b) Lesser sardines .. | 65,724 | 52,838 | 68,351 | 67,053 |
| | (c) <i>Hilsa ilisha</i> .. | 4,189 | 9,894 | 12,068 | 6,996 |
| | (d) Other <i>Hilsa</i> .. | 14,651 | 12,800 | 8,672 | 9,127 |
| | (e) <i>Anchoviella</i> .. | 34,033 | 39,054 | 26,588 | 33,684 |
| | (f) <i>Thrissocles</i> .. | 9,929 | 14,304 | 16,628 | 19,342 |
| | (g) Other clupeids .. | 41,458 | 37,020 | 33,965 | 38,270 |
| 6. | (a) <i>Harpodon nehereus</i> .. | 85,236 | 125,481 | 126,044 | 95,505 |
| | (b) <i>Saurida & Saurus</i> .. | 8,525 | 10,808 | 11,154 | 1,332 |
| 7. | <i>Hemirhamphus & Belone</i> .. | 2,311 | 1,478 | 1,577 | 1,653 |
| 8. | Flying fish .. | 643 | 1,681 | 2,546 | 1,255 |
| 9. | Perches .. | 31,799 | 49,312 | 35,657 | 38,541 |
| 10. | Red mullets .. | 2,422 | 2,984 | 3,130 | 2,416 |
| 11. | Polynemids .. | 3,929 | 5,469 | 5,809 | 6,056 |
| 12. | Sciaenids .. | 99,887 | 96,379 | 93,018 | 89,360 |
| 13. | Ribbon fish .. | 42,407 | 77,785 | 71,349 | 62,690 |
| 14. | (a) <i>Caranx</i> .. | 30,666 | 16,956 | 28,942 | 24,265 |
| | (b) <i>Chorinemus</i> .. | 4,119 | 3,359 | 3,307 | 4,182 |
| | (c) <i>Trachynotus</i> .. | 80 | 106 | 195 | 40 |
| | (d) Other carangids .. | 219 | 423 | 465 | 945 |
| | (e) <i>Coryphaena</i> .. | 226 | 64 | 146 | 302 |
| | (f) <i>Elacate</i> .. | 429 | 568 | 880 | 379 |
| 15. | (a) <i>Leiognathus</i> .. | 34,504 | 41,777 | 55,266 | 54,400 |
| | (b) <i>Gazza</i> .. | 61 | 104 | 197 | 186 |
| 16. | <i>L. actarius</i> .. | 10,961 | 7,906 | 4,474 | 7,415 |
| 17. | Pomfrets .. | 35,127 | 41,434 | 40,427 | 38,231 |
| 18. | Mackerel .. | 62,136 | 85,233 | 71,514 | 55,279 |
| 19. | Seer fish .. | 21,119 | 20,779 | 29,547 | 25,986 |
| 20. | Tunnies .. | 13,005 | 13,893 | 26,595 | 20,371 |
| 21. | <i>Sphyaena</i> .. | 2,423 | 3,709 | 2,265 | 1,782 |
| 22. | <i>Mugil</i> .. | 2,269 | 2,626 | 1,400 | 2,030 |
| 23. | <i>Bregmaceros</i> .. | 30 | 184 | 638 | 916 |
| 24. | Soles .. | 10,810 | 13,620 | 12,203 | 13,633 |
| 25. | (a) Penaeid prawns .. | 96,472 | 129,204 | 113,665 | 112,037 |
| | (b) Non-penaeid prawns .. | 73,992 | 50,652 | 63,917 | 58,700 |
| | (c) Lobsters .. | 1,217 | 1,307 | 1,135 | 679 |
| | (d) Other crustaceans .. | 20,068 | 14,202 | 20,304 | 25,386 |
| 26. | Cephalopods .. | 10,005 | 15,931 | 15,032 | 11,335 |
| 27. | Miscellaneous .. | 91,945 | 11,358 | 106,250 | 65,840 |
| | Total .. | 1,259,782 | 1,403,607 | 1,388,380 | 1,249,837 |

Appendix 5.7

ESTIMATED STATEWISE AND SPECIES-WISE MARINE FISH LANDINGS IN INDIA DURING 1980 (in tonnes)

| Sl. No. | Name of fish | West Bengal | Orissa | Andhra Pradesh | Tamil Nadu | Pondi-cherry | Kerala | Karna-taka | Goa | Maha-rashtra | Guja-rat | Anda-mans | Laksha-dweep | Private* Trawlers | Total |
|---------|--------------------------------|-------------|--------|----------------|------------|--------------|----------|------------|--------|--------------|----------|-----------|--------------|-------------------|-----------|
| 1. | Elasmobranchs | 114 | 3,772 | 4,842 | 15,442 | 435 | 6,803 | 2,910 | 894 | 7,752 | 14,558 | 56 | 284 | — | 57,862 |
| 2. | Eels | — | — | 289 | 85 | 8 | 6 | 131 | 6 | 3,154 | 8,403 | — | — | — | 12,082 |
| 3. | Catfishes | 723 | 2,198 | 2,338 | 4,047 | 78 | 13,936 | 5,354 | 1,151 | 8,653 | 5,235 | 32 | — | — | 43,745 |
| 4. | <i>Chirocentrus</i> | 276 | 1,460 | 1,123 | 2,695 | 98 | 1,002 | 171 | 124 | 2,039 | 3,792 | 25 | — | — | 12,805 |
| 5. | (a) Oil sardine | — | — | — | 320 | — | 69,667 | 42,727 | 2,367 | 663 | — | — | — | — | 1,15,744 |
| | (b) Lessersardines | — | 1,891 | 13,930 | 29,940 | 2,736 | 11,017 | 4,135 | 1,798 | 1,363 | — | 243 | — | — | 67,053 |
| | (c) <i>Hilsa ilisha</i> | 644 | 5,091 | 96 | 37 | 25 | 14 | 8 | 8 | 1,017 | 56 | — | — | — | 6,996 |
| | (d) Other <i>Hilsa</i> | 20 | 46 | 1,267 | 3,084 | 53 | 21 | 25 | 14 | 607 | 3,965 | 25 | — | — | 9,127 |
| | (e) <i>Anchoviella</i> | — | 270 | 6,182 | 13,128 | 287 | 7,772 | 5,621 | 249 | 78 | — | 99 | — | — | 33,684 |
| | (f) <i>Thrissoc/es</i> | 194 | 333 | 7,326 | 5,048 | 387 | 2,241 | 850 | 779 | 1,271 | 913 | — | — | — | 19,342 |
| | (g) Other clupeids | 674 | 2,576 | 5,486 | 1,833 | 273 | 574 | 1,088 | 302 | 16,897 | 8,538 | 29 | — | — | 38,270 |
| 6. | (a) <i>Harpodon nehereus</i> | 419 | 378 | 611 | 6 | — | — | 15 | 12 | 57,393 | 36,671 | — | — | — | 95,505 |
| | (b) <i>Saurida & Sauws</i> | — | 189 | 931 | 1,123 | 160 | 7,080 | 508 | 199 | 1,057 | 85 | — | — | — | 11,332 |
| 7. | <i>Hemirhamphus Be/one</i> | — | 46 | 97 | 749 | 26 | 361 | 180 | 6 | 42 | 6 | 41 | 99 | — | 1,653 |
| 8. | Flyin _g fish | — | 17 | 43 | 1,106 | 3 | — | 55 | 2 | — | — | — | 29 | — | 1,255 |
| 9. | Perches | 13 | 341 | 4,639 | 6,886 | 666 | 17,814 | 1,069 | 269 | 3,712 | 2,454 | 302 | 376 | — | 38,541 |
| 10. | Red mullets | — | 296 | 349 | 1,079 | 150 | — | 38 | 15 | 461 | — | — | 27 | — | 2,416 |
| 11. | Folysemids | 186 | 1,126 | 1,448 | 629 | 6 | 8 | — | 10 | 1,976 | 667 | — | — | — | 6,056 |
| 12. | Sciaanids | 358 | 2,864 | 9,496 | 19,547 | 320 | 6,164 | 3,500 | 1,530 | 13,956 | 31,625 | — | — | — | 89,360 |
| 13. | Ribbon fish | 142 | 928 | 5,646 | 7,862 | 179 | 12,937 | 1,499 | 1,089 | 11,550 | 10,858 | — | — | — | 62,690 |
| 14. | (a) <i>Caranx</i> | — | 607 | 5,981 | 5,405 | 479 | 4,399 | 4,507 | 884 | 1,315 | 461 | 147 | 80 | — | 24,265 |
| | (b) <i>Chorinemus</i> | 130 | 567 | 710 | 1,111 | 2 | 145 | 67 | 71 | 357 | 1,022 | — | — | — | 4,182 |
| | (c) <i>Trachynotus</i> | — | — | — | 38 | 2 | — | — | — | — | — | — | — | — | 40 |
| | (d) Other carangids | — | — | 97 | 188 | — | 59 | 232 | — | 369 | — | — | — | — | 945 |
| | (e) <i>Coryphaena</i> | — | — | 3 | 141 | — | 138 | — | — | 20 | — | — | — | — | 302 |
| | (f) <i>Elacate</i> | — | — | 19 | 148 | — | 19 | 3 | 190 | — | — | — | — | — | 379 |
| 15. | (a) <i>Leiognafws</i> | 34 | 704 | 3,775 | 38,163 | 681 | 4,147 | 4,671 | 1,727 | 406 | — | 102 | — | — | 54,400 |
| | (b) <i>Gazza</i> | — | 3 | 56 | 84 | — | 1 | 42 | — | — | — | — | — | — | 186 |
| 16. | <i>Lactarius</i> | — | 65 | 940 | 938 | 29 | 861 | 998 | 614 | 450 | 2,520 | — | — | — | 7,415 |
| 17. | Pomfrets | 921 | 9,072 | 2,201 | 1,306 | 188 | 907 | 696 | 257 | 10,081 | 12,587 | 15 | — | — | 38,231 |
| 18. | Mackerel | — | 265 | 6,203 | 7,229 | 445 | 18,474 | 19,634 | 2,446 | 288 | 112 | 183 | — | — | 55,279 |
| 19. | Seer fish | 234 | 1,542 | 2,970 | 7,179 | 85 | 3,763 | 1,941 | 735 | 3,219 | 4,180 | 117 | 21 | — | 25,986 |
| 20. | Tunnies | — | 34 | 419 | 4,233 | — | 10,611 | 952 | 356 | 1,674 | 277 | 55 | 1,760 | — | 20,371 |
| 21. | <i>Sphyræna</i> | — | 8 | 88 | 932 | 55 | 330 | 84 | 171 | 33 | — | 67 | 14 | — | 1,782 |
| 22. | <i>Mugil</i> | — | 1 | 27 | 577 | 49 | 151 | 39 | 11 | 24 | 1,034 | 117 | — | — | 2,030 |
| 23. | <i>Bregmaceros</i> | — | — | — | — | — | — | — | — | 159 | 757 | — | — | — | 916 |
| 24. | Soles | 3 | 69 | 573 | 2,094 | 151 | 4,394 | 782 | 1,311 | 1,797 | 2,459 | — | — | — | 13,633 |
| 25. | (a) Penaeid prawns | 152 | 1,074 | 5,660 | 9,082 | 485 | 52,633 | 3,098 | 1,853 | 23,433 | 14,481 | 54 | — | 32 | 1,12,037 |
| | (b) Non-penaeid | 48 | 30 | 4,346 | 946 | 42 | 1,742 | 128 | — | 47,309 | 4,109 | — | — | — | 58,700 |
| | (c) Lobsters | 20 | — | 10 | 90 | 4 | 18 | 110 | 18 | 225 | 204 | — | — | — | 679 |
| | (d) Other crustaceans | 20 | 359 | 1,413 | 6,174 | 172 | 7,286 | 2,765 | 1,933 | 297 | 4,967 | — | — | — | 25,386 |
| 26. | Cephalopods | 4 | 98 | 470 | 1,472 | 40 | 4,244 | 122 | 210 | 1,191 | 3,471 | — | 13 | — | 11,335 |
| 27. | Miscellaneous | 788 | 1,055 | 3,913 | 15,230 | 591 | 7,803 | 4,567 | 879 | 5,475 | 23,027 | 94 | 206 | 2,212 | 65,840 |
| TOTAL | | 6,097 | 39,375 | 1,16,013 | 2,17,394 | 9,390 | 2,79,543 | 1,15,322 | 24,490 | 2,31,763 | 2,03,494 | 1,803 | 2,909 | 2,244 | 12,49,837 |

Partial coverage of larger trawlers

Source: Marine Fisheries Information Service, October 1981

Appendix 6.1**STATEWISE CAPACITIES FOR FISH CANNING AND FISH MEAL MANUFACTURE**

| States | Canning | | Fish Meal | |
|----------------|---------|----------|-----------|----------|
| | Nos. | Capacity | Nos. | Capacity |
| Kerala | 42 | 156.49 | 3 | 62.50 |
| Karnataka | 9 | 38.00 | 5 | 150.00 |
| Tamil Nadu | 3 | 4.50 | 6 | 62.00 |
| Andhra Pradesh | 1 | 0.05 | — | — |
| Pondicherry | 1 | 3.00 | — | — |
| Lakshadweep | 1 | 3.00 | — | — |
| Maharashtra | 3 | 5.50 | 6 | 95.00 |
| Gujarat | 1 | 6.40 | 12 | 194.00 |
| Goa | 7 | 33.50 | 1 | 12.00 |
| Orissa | 1 | 1.00 | — | — |
| West Bengal | — | — | 1 | 14.00 |
| Total | 69 | 251.44 | 34 | 589.50 |

Source: MPEDA, Cochin.

Appendix 8.1

STRUCTURE OF EXPORTS OF MARINE PRODUCTS FROM INDIA YEAR-WISE BY BROAD CATEGORIES (1977/78 TO 1979/80)

| Items | Quantity (tonnes) | | Value (Rs. million) | | | |
|---------------------------------|-------------------|-------------|---------------------|-------------|--------------|-------------|
| | 1977/78 | | 1978/79 | | 1979/80 | |
| | Quantity | Value | Quantity | Value | Quantity | Value |
| 1. Frozen shrimp | 50067 | 1583 | 51162 | 1948 | 51068 | 2112 |
| 2. Frozen lobster tails | 637 | 40 | 732 | 51 | 560 | 41 |
| 3. Frozen froglegs | 2899 | 67 | 4087 | 99 | 2926 | 63 |
| 4. Fresh & frozen fish | 3140 | 32 | 16757 | 98 | 22629 | 133 |
| 5. Frozen cuttle fish & fillets | 977 | 14 | 1062 | 19 | 1551 | 43 |
| 6. Frozen squids | 654 | 7 | 2755 | 37 | 2244 | 30 |
| 7. Canned shrimp | 129 | 5 | 197 | 9 | 231 | 11 |
| 8. Dried fish | 4230 | 23 | 6909 | 37 | 3357 | 16 |
| 9. Dried shrimp | 235 | 2 | 19 | — | 19 | — |
| 10. Shark fins and fish maws | 289 | 25 | 416 | 33 | 341 | 27 |
| 11. Miscellaneous items | 2710 | 12 | 2798 | 15 | 1475 | 12 |
| Total | 65967 | 1810 | 86894 | 2346 | 86401 | 2488 |

Source: The Marine Products Exports Development Authority, Cochin (1980).

Appendix 8.2

PERCENTAGE COMPOSITION OF MARINE PRODUCTS EXPORTED FROM INDIA (1978/79-1979/80)

| Items | 1977/78 | | 1978/79 | | 1979/80 | |
|-----------------------------------|---------------|---------------|---------------|---------------|---------------|---------------|
| | Quantity | Value | Quantity | Value | Quantity | Value |
| | (Percentage) | | | | | |
| 1. Frozen shrimp | 75.90 | 87.48 | 58.88 | 83.02 | 59.11 | 84.90 |
| 2. Frozen lobster tails | 0.96 | 2.19 | 0.84 | 2.19 | 0.65 | 1.63 |
| 3. Frozen froglegs | 4.39 | 3.69 | 4.70 | 4.23 | 3.39 | 2.55 |
| 4. Fresh & Frozen Fish | 4.76 | 1.75 | 19.29 | 4.16 | 26.79 | 5.35 |
| 5. Frozen cuttle fish and fillets | 1.48 | 0.79 | 1.22 | 0.81 | 1.80 | 1.72 |
| 6. Frozen squids | 0.99 | 0.37 | 3.17 | 1.57 | 2.60 | 1.19 |
| 7. Canned shrimp | 0.20 | 0.31 | 0.23 | 0.37 | 0.27 | 0.45 |
| 8. Dried fish | 0.36 | 0.10 | 0.02 | 0.01 | 0.02 | 0.01 |
| 9. Dried shrimp | 6.41 | 1.25 | 7.95 | 1.56 | 3.89 | 0.63 |
| 10. Shark fin and fish maws | 0.44 | 1.38 | 0.48 | 1.42 | 0.39 | 1.08 |
| 11. Miscellaneous items | 4.11 | 0.69 | 3.22 | 0.66 | 1.69 | 0.49 |
| Total | 100.00 | 100.00 | 100.00 | 100.00 | ~00.00 | 100.00 |

Source: The Marine Products Exports Development Authority, Cochin, 1980.

Appendix 9.1

SELECTED DATA ON PRODUCTION RATES IN
BRACKISHWATER FISH/PRAWN CULTURE

| Place | Year | Fishery | Production/ha. kg |
|----------|---------|------------------|-------------------------------|
| 1 | 2 | 3 | 4 |
| Kerala | 1954 | Prawn filtration | 1079/6-7 months |
| " | 1956 | " | 1184/ " |
| " | 1968 | " | 514/ " |
| " | 1974 | " | 754-1060 " |
| " | 1977 | " | 637/ " |
| " | 1978 | " | 734 " |
| " | 1976-78 | P. indicus | 272 (214-38) in 3-4 months |
| Madras | 1976-78 | P. indicus | 3 0 1 , 7 0 4 " |
| | 1976-78 | P. monodon | 515 " |
| Kakdwip | 1978-79 | | 1185 in several crops a year |
| Madras | " | P. monodon | 1400 -do- |
| Kakinada | " | P. monodon | 300 -do- |
| | " | P. indicus | 480 -do- |
| Panaji | " | Mixed culture | 890,1730, 1168 per year |
| Kakdwip | " | " | 2585,1168 " |
| Kakinada | | | 1060 |
| Kakdwip | 1979-80 | P. monodon | 133349 in 2½-3½ months |
| Keshpur | " | " | 122-268 in 5-7½ months |
| Kakinada | " | " | 100-440 in 3-6 months |
| Madras | " | " | 74-440 in 3-6 months |
| Vijtilla | " | " | 7-71 in 1½-4½months |
| Goa | " | | 133 in 4 months |
| Keshpur | " | P. indicus | 135-209 in 6-7 months |
| Madras | " | " | 152-458 in 3 months |
| Vijtilla | " | " | 8-19 |
| Goa | " | | 102-288 in 1½ to 3½ months |
| Keshpur | " | Chanos | 903 in 7 months |
| Kakinada | " | | 165-565 in 3-6 months |
| Keshpur | " | Mulletts | 504 in 7 months |
| Kakinada | " | " | 11 89 in one year |
| Kakdwip | " | " | 1125,1369 in 89 months |
| Kakdwip | " | Lates | 1583 in 6½ months |

Appendix 10.1

STATEWISE FIGURES OF MARINE FISHING VILLAGES AND FISHERFOLK POPULATION IN INDIA-1980

| | STATES | | | | | | | | | |
|---|-------------|----------|----------------|------------|--------------------------------------|----------|-----------|----------------|----------|-----------|
| | West Bengal | Orissa | Andhra Pradesh | Tamil Nadu | Pondicherry, Karaikal, Mahe Et Yenam | Kerala | Karnataka | Goa, Daman Diu | Gujarat | Total |
| 1. No. of fishing villages | 303 | 236 | 453 | 422 | 27 | 304 | 147 | 61 | 179 | 2,132 |
| 2. No. of landing centres | 47 | 56 | 379 | 375 | 27 | 222 | 105 | 54 | 173 | 1,438 |
| 3. No. of fishermen households | 14,169 | 20,329 | 72,862 | 75,721 | 4,625 | 99,894 | 15,638 | 6,725 | 23,075 | 3,33,038 |
| 4. Fishermen population | | | | | | | | | | |
| (a) Adults: Male | 27,547 | 37,536 | 97,364 | 1,26,967 | 7,362 | 2,10,609 | 32,715 | 12,459 | 42,835 | 5,95,394 |
| Female | 23,624 | 33,837 | 96,459 | 1,26,691 | 7,544 | 2,09,853 | 34,888 | 12,398 | 42,249 | 5,87,543 |
| (b) Children | 32,390 | 45,771 | 1,32,481 | 1,42,245 | 10,406 | 2,19,410 | 45,290 | 15,055 | 66,931 | 7,09,979 |
| Total | 83,561 | 1,17,144 | 3,26,304 | 3,95,903 | 25,312 | 6,39,872 | 1,12,893 | 39,912 | 1,52,015 | 18,92,916 |
| 5. Educational status | | | | | | | | | | |
| (a) Primary | 1,5,606 | 7,618 | 20,386 | 60,075 | 4,922 | 1,19,823 | 21,596 | 7,060 | 23,901 | 2,80,987 |
| (b) Secondary | 2,752 | 2,045 | 3,562 | 11,897 | 1,370 | 23,514 | 5,174 | 2,617 | 4,067 | 56,998 |
| (c) Above secondary | 452 | 359 | 429 | 3,860 | 270 | 5,317 | 1,553 | 338 | 911 | 13,489 |
| Total | 18,810 | 10,022 | 24,377 | 75,832 | 6,562 | 1,48,654 | 28,323 | 70,015 | 28,879 | 3,51,474 |
| 6. No. of fishermen engaged in actual fishing | | | | | | | | | | |
| (a) Full time | 9,026 | 20,617 | 73,506 | 87,442 | 5,021 | 1,19,970 | 17,664 | 6,841 | 25,616 | 3,57,703 |
| (b) Part time | 9,497 | 6,262 | 4,910 | 4,020 | 187 | 11,017 | 5,558 | 1,362 | 6,841 | 49,654 |
| (c) Occasional | 1,233 | 3,845 | 5,487 | 5,038 | 304 | 8,114 | 1,783 | 668 | 4,070 | 30,542 |
| Total | 19,756 | 30,724 | 83,903 | 96,500 | 5,512 | 1,31,101 | 25,005 | 8,871 | 36,527 | 4,37,899 |

Source: Marine Fisheries Information Service.

ORGANISATIONAL SET-UP OF THE FISHERIES ADMINISTRATION
IN THE GOVERNMENT OF INDIA

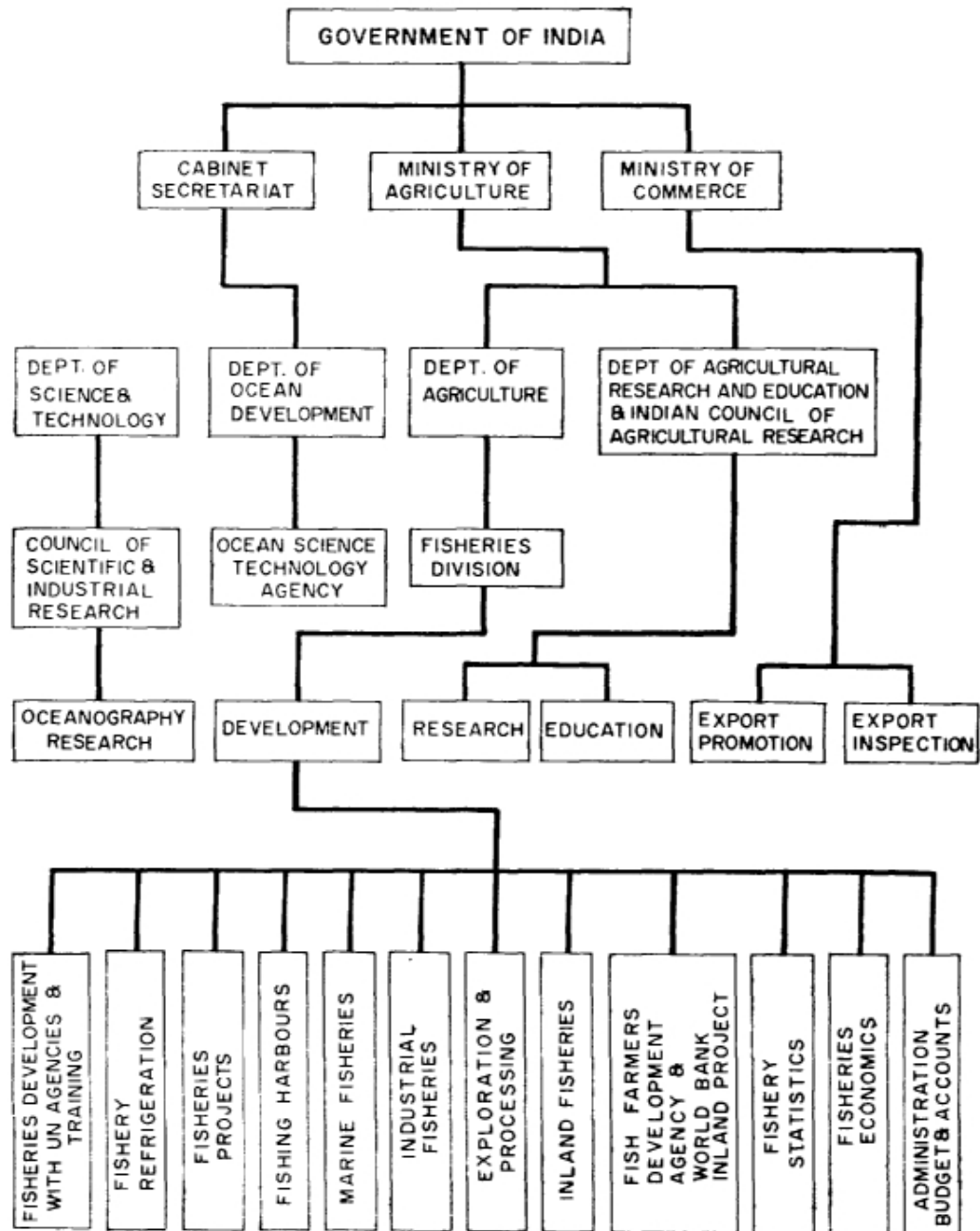

APPENDIX - 11.2

NODAL ORGANISATIONS AND THE SPECIALISED INSTITUTES
UNDER THEIR ADMINISTRATIVE CONTROL

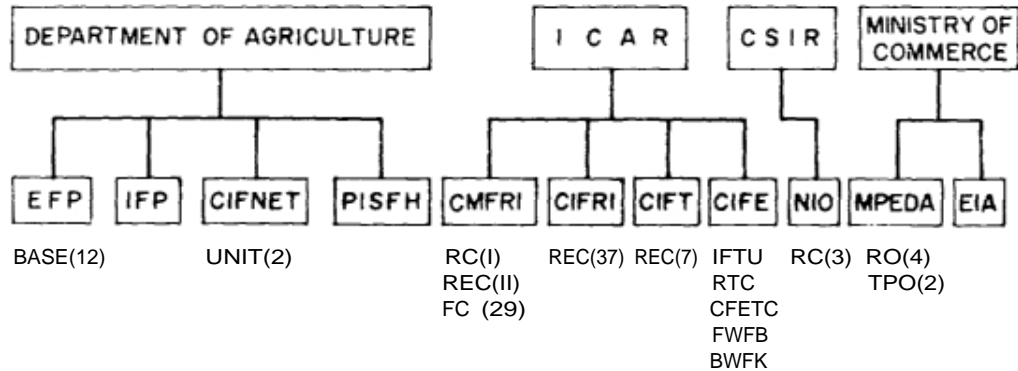

- ICAR – INDIAN COUNCIL OF AGRICULTURAL RESEARCH
 CSIR – COUNCIL OF SCIENTIFIC AND INDUSTRIAL RESEARCH
 EFP – EXPLORATORY FISHERIES PROJECT, BOMBAY (ESTD. 1946)
 IFP – INTEGRATED FISHERIES PROJECT, COCHIN (ESTD. 1952)
 CIFNET – CENTRAL INSTITUTE OF FISHERIES NAUTICAL AND ENGINEERING TRAINING, COCHIN (ESTD. 1963)
 PISFH – PRE-INVESTMENT SURVEY OF FISHING HARBOURS PROJECT, & ANGALORE (ESTD. 1968)
 CMFRI – CENTRAL MARINE FISHERIES RESEARCH INSTITUTE, COCHIN (ESTD. 1947)
 CIFRI – CENTRAL INLAND FISHERIES RESEARCH INSTITUTE, BARRACKPORE (ESTD. 1947)
 CIFT – CENTRAL INSTITUTE OF FISHERIES TECHNOLOGY, COCHIN (ESTD. 1957)
 CIFE – CENTRAL INSTITUTE OF FISHERIES EDUCATION, BOMBAY (ESTD. 1961)
 NIO – NATIONAL INSTITUTE OF OCEANOGRAPHY, GOA (ESTD. 1966)
 MPEDA – MARINE PRODUCTS EXPORT DEVELOPMENT AUTHORITY, COCHIN (ESTD. 1972)
 IFTU – INLAND FISHERIES TRAINING UNIT, BARRACKPORE (ESTD. 1947)
 RTC – REGIONAL TRAINING CENTRE FOR INLAND FISHERIES OPERATIVES, AGRA (ESTD. 1967)
 CFETC – CENTRAL FISHERIES EXTENSION TRAINING CENTRE, HYDERABAD (ESTD. 1973)
 FWFB – FRESH WATER FISH FARM, BALABHADRAPURAM (A.P.)
 BWFK – BRACKISHWATER FISH FARM, XAKINADA (A.P.)
 EIA – EXPORT INSPECTION AGENCY
 RC – REGIONAL CENTRE
 REC – RESEARCH CENTRE
 FC – FIELD CENTRE
 RO – REGIONAL OFFICE
 TPO – TRADE PROMOTION OFFICE
 RU – RESEARCH UNIT

Appendix 12.1

SUBSIDIES PROVIDED BY DIFFERENT STATES IN THE FISHERIES SECTOR

| Sl. No. | Name of item | Gujarat | Maha-rashtra | Goa | Karnataka | Kerala | Tamil Nadu | Pondi-cherry | Orissa | Andaman & Nicobar Islands | Laksha-dweep |
|---------|------------------------------|----------------|-----------------|----------------|----------------------|---------------|------------|----------------|--------|---------------------------|--------------|
| 1. | Wooden unmechanised boat . . | .. | .. | .. | 50% (1000) | 15% | .. | 12.5% | 25% | 70% | .. |
| 2. | Wooden hull | 7.5% (5000) | 45% | 10% | 25% | .. | .. | 12.5% | 25% | 70% | 20% |
| 3. | FRP boat | .. | .. | .. | .. | .. | 20% | .. | .. | .. | .. |
| 4. | Marine diesel engine | 30% (20000) | 45% | 10-20% | .. | .. | 20% | 12.5% | 25% | 70% | 33.3% |
| 5. | Out board engine | 15% (400) | .. | .. | 33.3% | 25% (3000) | 20% | 12.5% | 25% | 70% | 33.3% |
| 6. | Purse-seine/gillnet | .. | .. | 25% (20000) | 25% (12500-30000) | .. | .. | .. | .. | .. | .. |
| 7. | Nylon net/twine | 10% | 15% Rs. 6/kg | Rs. 6/kg | 25- 33.3% | .. | 20% | 20% | 25-50% | 60% | .. |
| 8. | Cotton net/twine | .. | 25% | Rs. 2/kg | 33.3% | .. | .. | 20% | 25-50% | 60% | 25% |
| 9. | Housing | .. | .. | .. | .. | (2000) | 100% | .. | .. | 50% | .. |
| 10. | Godown | .. | .. | 25% | 50% | .. | .. | 50% (10000) | .. | .. | .. |
| 11. | Ice plant and cold storage | .. | 45% | 20% | 25% (20000) | .. | .. | su bsidised | .. | .. | .. |
| 12. | Fish transport vehicle | .. | 50% | .. | 50% | .. | .. | .. | .. | .. | .. |
| 13. | Diesel oil | .. | (1000) | .. | .. | .. | .. | .. | .. | .. | 15 p/L |

Note: The above list is not complete and subject to other conditions. Financial limits are given in Rs. in brackets. This does not include loan assistance. No information has been received from Andhra Pradesh and West Bengal.

Appendix 14.1**OUTLAYS AND EXPENDITURE FOR
FISHERY DEVELOPMENT DURING THE PLAN PERIODS***(Rs. in million)*

| Plan period | Outlay | Expenditure |
|---|---------|-------------|
| First Five-Year Plan (1951-56) | 51.3 | 27.8 |
| Second Five-Year Plan (1956-61) | 122.6 | 90.6 |
| Third Five-Year Plan (1961-66) | 282.7 | 233.7 |
| Annual Plan — 1968-69 | 422.1 | 316.7 |
| Fourth Five-Year Plan (1969-1974) | 826.8 | 511.1 |
| Fifth Five-Year Plan (1974-79) | 1,512.4 | 1,349.8 |
| Annual Plans | | |
| 1978-79 to 1979-80 | 1,493.0 | 780.6 |
| Sixth Plan (1980-85) | 3,711.4 | |

Appendix 14.2

CENTRAL SECTOR AND CENTRALLY SPONSORED SCHEMES — OUTLAYS IN THE SIXTH FIVE-YEAR PLAN (1980-85)

(Rs. in million)

| S.No. | Name of the Scheme | Sixth Plan outlays 1980-85 |
|--|---|----------------------------------|
| I. Central Sector Schemes Continuing | | |
| 1. | Exploratory Fisheries Project | 480.0 |
| 2. | Fish Processing and Marketing Project — Integrated Fisheries Project | 28.5 |
| 3. | Central Institute of Fisheries, Nautical and Engineering Training | 70.0 |
| 4. | Coastal Engineering Project (Pre-Investment Survey of Fishing Harbours) | 7.5 |
| 5. | Landing and Berthing facilities for Fishing Crafts at Major Ports | 170.0 |
| 6. | Fish Processing and Marketing Surveys | 4.1 |
| 7. | Trawler Development Fund | 500.0 |
| 8. | Other schemes | 2.5 |
| | Sub-Total : | 1262.6 |
| NEW | | |
| 9. | National Programme for Fish Seed Development | 80.0 |
| 10. | Augmentation of Slipway Facilities at Goa Shipyard | 16.5 |
| 11. | Pilot Project on Reservoir Fisheries under Technical Assistance component on Inland Fisheries Project with World Bank Assistance. | 1.9 |
| 12. | Sample Surveys for Inland Fisheries statistics | 10.0 |
| | Sub-Total : | 108.4 |
| | Total (Central Sector Schemes) | 1371.0 |
| II. Centrally Sponsored Scheme Continuing | | |
| 1. | Development of Aquaculture — FFD | 50.0 |
| 2. | Landing and Berthing Facilities for Fishing Crafts at Minor Ports | 190.0 |
| 3. | Development of infrastructural facilities for Coastal Fishing Villages* | Nil |
| | Sub-Total : | 240.0 |
| NEW | | |
| 4. | Accelerated Programme of Establishment of Prawn Hatcheries and Prawn Farming in the Maritime States | 50.0 |
| 5. | Inland Fisheries Project with World Bank Assistance — FFDA | 76.2 |
| 6. | Development of Fisheries in Assam | — |
| | Sub-Total | 126.2 |
| | Total (Centrally Sponsored Schemes) | 366.2 |
| | Grand Total (Central and Centrally Sponsored Schemes) | 1737.2 |

*Scheme dropped in the Sixth Five-Year Plan 1980-85.

Contingent scheme induction Annual Plan 1980-81.

Source: Annual Plan Proposals 1981-82, Central and Centrally Sponsored Schemes, Ministry of Agriculture, Department of Agriculture and Cooperation.

Appendix 14.3

STATEWISE OUTLAYS FOR FISHERIES DURING SIXTH PLAN

(Rs. in million)

| State/U.T. | Sixth Plan (1980—85) approved outlay |
|--------------------------|---|
| 1. Andhra Pradesh | 140.0 |
| 2. Assam | 60.0 |
| 3. Bihar | 69.6 |
| 4. Gujarat | 200.0 |
| 5. Haryana | 19.5 |
| 6. Himachal Pradesh | 18.0 |
| 7. Jammu & Kashmir | 23.0 |
| 8. Karnataka | 130.3 |
| 9. Kerala | 200.0 |
| 10. Madhya Pradesh | 70.0 |
| 11. Maharashtra | 120.7 |
| 12. Manipur | 25.0 |
| 13. Meghalaya | 9.0 |
| 14. Nagaland | 7.0 |
| 15. Orissa | 100.0 |
| 16. Punjab | 17.5 |
| 17. Rajasthan | 22.5 |
| 18. Sikkim | 10.0 |
| 19. Tamil Nadu | 240.0 |
| 20. Tripura | 33.3 |
| 21. Uttar Pradesh | 65.9 |
| 22. West Bengal | 270.0 |
| Total States | 1851.3 |
| 23. Andamans | 20.0 |
| 24. Arunachal Pradesh | 7.8 |
| 25. Chandigarh | 1.0 |
| 26. Delhi | 6.0 |
| 27. Goa | 40.0 |
| 28. Lakshadweep | 17.5 |
| 29. Mizoram | 6.0 |
| 30. Pondicherry | 24.1 |
| 31. Dadra & Nagar Haveli | 0.5 |
| Total (U.Ts.) | 122.9 |
| Grand Total | 1974.2 |

Source: (i) Annual Plan proposals 1981—82.

(ii) Sixth Plan proposals 1980—85 Ministry of Agriculture.

Appendix 14.4**STATE PLAN OUTLAY FOR FISHERIES DEVELOPMENT
BY BROAD HEADS OF DEVELOPMENT**

| S.No. | Heads of development | Sixth plan outlay (state sector) | |
|-------|---|-------------------------------------|--------|
| | | As percentage of total | |
| 1. | Inland fisheries | .. | 35.47 |
| 2. | Mechanization and improvement of fishing crafts | .. | 7.67 |
| 3. | Deep sea fishing | .. | 18.12 |
| 4. | Processing, preservation and marketing | .. | 5.84 |
| 5. | Research | .. | 2.46 |
| 6. | Extension | .. | 4.35 |
| 7. | Education and training | .. | 2.68 |
| 8. | Direction and administration | .. | 3.12 |
| 9. | Others | .. | 20.28 |
| | Total | .. | 100.00 |

Appendix 14.5

LIST OF AID PROJECTS

A. Technical assistance

- | | | |
|---|---|--|
| 1. FAO/UNDP (Regional) (Completed) | Small-Scale Fisheries Promotion in South Asia. RAS/77/044 (Bangladesh, India, Pakistan, Sri Lanka and Thailand). — to assess and document the small-scale fisheries in the participating countries; -to prepare project reports, programmes and plans for small-scale fisheries development; and — to enlist support to small-scale fisheries from bilateral and multi-lateral developmental agencies and financing institutions. | January 1978-December 1981 Duration : 48 months Budget: UNDP : \$383,905 Host Govt. : India |
| 2. FAO/SIDA (Regional) | Development of Small-Scale Fisheries in the Bay of Bengal. GCP/RAS/040/SWE (Bangladesh, Sri Lanka, India, Thailand and Malaysia) — to assist participating countries to improve the standard of living and the quality of life of their small-scale fishermen families and increase supplies of fish. | Started : August 1978 Duration : Up to 6 years (preparatory phase 1 year) Host Govt. : India Budget: \$ 7.7 million |
| 3. FAO/TCP (National) | Propeller nozzles for trawlers — TCP/IND/0005 (T) — to introduce fixed nozzles to existing fleet of trawlers | Started : April 1980 Completion : March 1982 FAO contribution : US \$106000 GOI contribution : INR 6000000 +local facilities |
| B. Investment Projects | | |
| 4 . NORAD | Boatbuilding Programme, including strengthening of yard facilities at Goa Shipyard, Goa. — to construct 8 fishing vessels for survey and training. | Started : 1975 Completion date : Extended over originally anticipated date Norad contribution: Nkr. 66 million (Rs. 99 million). Indian contribution : Rs. 89.1 million |
| 5 . NORAD | Fisheries Development Project, Balasore — Community development of Choumukh village in Balasore district (Orissa). | Yet to start; preliminary work in progress. NORAD contribution : Nkr. 13.3 million |
| 6 . DANIDA (Completed) | Assistance in Fisheries Development. — Supply of 4 fishing vessels, 2 for survey and 2 for training. | Duration : 1978-79 DANIDA contribution : Rs. 70 million Indian contribution : Nil |
| 7 . DANIDA (Pipeline) | Tadri Community Development Project. | Proposed duration : 7 years DANIDA contribution : Rs. 60 million Indian contribution : Local costs |

| | | |
|---------------------------|--|---|
| 8. Japan (completed) | Assistance for fisheries development — Supply of 2 fishing vessels, 1 for survey and 1 for training | Duration : 1978-79 Japan contribution : Yen 600 million Indian contribution : Nil |
| 9. Holland (completed) | Assistance for fisheries development -Supply of 3 fishing vessels for survey. | Duration : 1977-79 Dutch contribution : Rs. 59.8 million Indian contribution : Nil |
| 10. UK (Pipeline) | Assistance for fisheries development — Development of Astrang fishing harbour. — Development of Krishnapatnam fishing harbour. | UK contribution : Rs. 16.95 million |
| 11. World Bank | Integrated Marine Fisheries Project in Gujarat. — Construction of fishing harbours at Veraval and Mangrol; — Development of traditional fisheries — Freezing and processing facilities — Technical assistance | WB aid : US \$ 14 million GOI/State : US \$ 20 million Starting : July 1977 Closing : June 1983 |
| 12. World Bank | Integrated Fisheries Project in Gujarat and Andhra Pradesh. — technical assistance — provision of services of experts etc. | WB aid : US \$ 4.0 million GOI/State: Nil Starting : July 1977 Closing : June 1983 |
| 13. World Bank | Integrated Marine Fisheries Project in Andhra Pradesh. — Development of fishing harbours at Visakhapatnam, Kakinada and Nizampatnam. — Introduction of mechanised and non-mechanised fishing vessels. — Creation of processing facilities — Approach roads — Technical assistance | WB aid : US \$ 17.5 million GOI/State : US \$ 19.0 million Starting : October 1978 Closing : September 1984 |
| 14. World Bank | Inland Fisheries Project in Five States. — to increase carp production — to provide basis for future commercial development in India. | WB aid : US \$ 20.0 million GOI/States : US \$ 24.0 million Starting : January 1980 Closing : September 1985 |

Publications of the Bay of Bengal Programme (BOBP)

Development of Small-Scale Fisheries (GCP/RAS/040/SWE)

Reports (BOBPIREPI. . . .)

1. Report of the First Meeting of the Advisory Committee.
Colombo, Sri Lanka, 28-29 October 1976.
(Published as Appendix I of IOFC/DEV/78/44.1, FAO, Rome, 1978)
2. Report of the Second Meeting of the Advisory Committee.
Madras, India, 29-30 June 1977.
(Published as Appendix 2 of IOFC/DEV/78/44.1, FAO, Rome, 1978)
3. Report of the Third Meeting of the Advisory Committee.
Chittagong, Bangladesh, 1-10 November 1978. Colombo, Sri Lanka, 1978.
(Reissued Madras, India, September 1980)
4. Role of Women in Small-Scale Fisheries of the Bay of Bengal.
Madras, India, October 1980.
5. Report of the Workshop on Social Feasibility in Small-Scale Fisheries Development.
Madras, India, 3-8 September 1979. Madras, India, April 1980.
6. Report of the Workshop on Extension Service Requirements in Small-Scale Fisheries.
Colombo, Sri Lanka, 8-12 October 1979. Madras, India, June 1980.
7. Report of the Fourth Meeting of the Advisory Committee.
Phuket, Thailand, 27-30 November 1979. Madras, India, February 1980.
8. Pre-Feasibility Study of a Floating Fish Receiving and Distribution Unit for Dubla Char,
Bangladesh. G. Eddie, M. T. Nathan. Madras, India, April 1980.
9. Report of the Training Course for Fish Marketing Personnel of Tamil Nadu.
Madras, India, 3-14 December 1979. Madras, India, September 1980.
- 10.1 Report of the Consultation on Stock Assessment for Small-Scale Fisheries in the
Bay of Bengal. Chittagong, Bangladesh, 16-21 June 1980.
Volume 1 : Proceedings. Madras, India, September 1980.
- 10.2 Report of the Consultation on Stock Assessment for Small-Scale Fisheries in the
Bay of Bengal. Chittagong, Bangladesh, 16-21 June 1980.
Volume 2 : Papers. Madras, India, October 1980.
11. Report of the Fifth Meeting of the Advisory Committee, Penang, Malaysia,
4-7 November 1980. Madras, India, January 1981.
12. Report of the Training Course for Fish Marketing Personnel of Andhra Pradesh.
Hyderabad, India, 11-26 November 1980. Madras, India, September 1981.
13. Report of the Sixth Meeting of the Advisory Committee.
Colombo, Sri Lanka, 1-5 December 1981. Madras, India, February 1982.
14. Report of the First Phase of the "Aquaculture Demonstration for Small-Scale Fisheries
Development Project" in Phang Nga Province, Thailand. Madras, India, March 1982.
15. Report of the Consultation-cum-Workshop on Development of Activities for Improve-
ment of Coastal Fishing Families. Dacca, Bangladesh, October 27-November 6, 1981.
Madras, India, May 1982.

Working Papers (BOBPI/WPI. . .)

1. **Investment Reduction and Increase in Service Life of Kattumaram Logs.**
R. Balan. Madras, India, February 1980.
2. **Inventory of Kattumarams and their Fishing Gear in Andhra Pradesh and Tamil Nadu.**
T. R. Menon. Madras, India, October 1980.
3. **Improvement of Large-Mesh Driftnets for Small-Scale Fisheries in Sri Lanka.**
G. Pajot. Madras, June 1980.
4. **Inboard Motorisation of Small G.R.P. Boats in Sri Lanka.**
Madras, India, September 1980.
5. **Improvement of Large-Mesh Driftnets for Small-Scale Fisheries in Bangladesh.**
G. Pajot. Madras, India, September 1980.
6. **Fishing Trials with Bottom-Set Longlines in Sri Lanka.**
G. Pajot, K. T. Weerasooriya. Madras, India, September 1980.
7. **Technical Trials of Beachcraft Prototypes in India.**
£ Gulbrandsen, G. P. Gowing, R. Ravikumar. Madras, India, October 1980.
8. **Current Knowledge of Fisheries Resources in the Shelf Area of the Bay of Bengal.**
B. T. Antony Raja. Madras, India, September 1980.
9. **Boatbuilding Materials for Small-Scale Fisheries in India.**
Madras, India, October 1980.
10. **Fishing Trials with High-Opening Bottom Trawls in Tamil Nadu, India.**
G. Pajot, John Crockett. Madras, India, October 1980.
11. **The Possibilities for Technical Cooperation between Developing Countries (TCDC) in Fisheries.** E. H. Nichols. Madras, India, August 1981.
12. **Trials in Bangladesh of Large-Mesh Driftnets of Light Construction.**
G. Pajot, T. K. Das. Madras, India, October 1981.
13. **Trials of Two-Boat Bottom Trawling in Bangladesh.**
G. Pajot, J. Crockett. Madras, India, October 1981.
14. **Three Fishing Villages in Tamil Nadu.**
Edeltraud Drewes. Madras, India, February 1982.
15. **Pilot Survey of Driftnet Fisheries in Bangladesh.**
M. Bergstrom. Madras, India, May 1982.
16. **Further Trials with Bottom Longlines in Sri Lanka.** Madras, India, July 1982.
17. **Exploration of the Possibilities of Coastal Aquaculture Development in Andhra Pradesh.**
Soleh Samsi, Sihar Siregar and Martono of the Directorate General of Fisheries, Jakarta, Indonesia. Madras, India, August 1982.
18. **Review of Brackishwater Aquaculture Development in Tamil Nadu.**
Kasemsant Chalayondeja and Anant Saraya of the Department of Fisheries, Thailand. Madras, India, September 1982.

Miscellaneous Papers (BOBPIMIS/. . . .)

1. **Fishermen's Cooperatives in Kerala : A Critique.**
John Kurien. Madras, India, October 1980.

Newsletters:

Bay of Bengal News. January 1981, May 1981, September 1981, December 1981, March 1982, June 1982, September 1982.

information Documents: (BOBPIINFI.. . .)

1. Women and Rural Development in the Bay of Bengal Region :
Information Sources. Madras, India, February 1982.
2. Fish Aggregation Devices : Information Sources.
Madras, India, February 1982.
3. Marine Small-Scale Fisheries of India : A General Description.
Madras, India, October 1982.