

IRRIGATION WATER MANAGEMENT
Training Manual No. 9

ISSN 1 020-4261

DRAINAGE OF IRRIGATED LANDS



Food
and
Agriculture
Organization
of the
United
Nations



IRRIGATION WATER MANAGEMENT
Training Manual No. 9

DRAINAGE OF IRRIGATED LANDS

A manual based on the joint work of
H.P. Ritzema
R.A.L. Kselik
International Institute for Land Reclamation and Improvement
and
Fernando Chanduvi
FAO Land and Water Development Division

FOOD AND AGRICULTURE ORGANIZATION OF THE UNITED NATIONS
Rome, 1996

The designations employed and the presentation of material in this publication do not imply the expression of any opinion whatsoever on the part of the Food and Agriculture Organization of the United Nations concerning the legal status of any country, territory, city or area or of its authorities, or concerning the delimitation of its frontiers or boundaries.

M-56
ISBN 92-5-103779-5

All rights reserved. No part of this publication may be reproduced, stored in a retrieval system, or transmitted in any form or by any means, electronic, mechanical, photocopying or otherwise, without the prior permission of the copyright owner. Applications for such permission, with a statement of the purpose and extent of the reproduction, should be addressed to the Director, Publications Division, Food and Agriculture Organization of the United Nations, Viale delle Terme di Caracalla, 00100 Rome, Italy.

© FAO 1996

Drawings by J. van Dijk, The International Institute for Land Reclamation and Improvement, Wageningen, The Netherlands.

Photographs: FAO Photo Library; ILRI Photo Library; and B.E. van den Bosch, Consultant.

Preface

This is one in a series of training manuals on subjects related to irrigation, issued in the period from 1985 to 1995. The manuals are intended for use by field assistants in agricultural extension services and irrigation technicians at the village and district levels who want to increase their ability to deal with farm-level irrigation issues.

The manuals contain material that is intended to provide support for irrigation training courses. Taken together, they do not present a complete course in themselves, but instructors may find them helpful when specific irrigation conditions are under discussion. The material may also be useful to individual students who want to review a particular subject without a teacher.

Following an introductory discussion of various aspects of irrigation in the first manual, subsequent subjects that have been discussed are:

- topographic surveying
- crop water needs
- irrigation scheduling
- irrigation methods
- scheme irrigation water needs and supply
- canals
- structures for water control and distribution
- drainage of irrigated land.

A further subject to be covered is:

- irrigation scheme operation and management.

At this stage, all the papers are regarded as being provisional because there is, as yet, little experience in preparing irrigation training material for use at the village level. After a trial period of a few years, when enough time has elapsed to evaluate the information and the methods outlined in the draft manuals, a definitive version of the series can be issued.

For further information and any comments you may wish to make, please write to:

Water Resources, Development and Management Service
Land and Water Development Division
FAO
Viale delle Terme di Caracalla
I-00100 Rome
Italy

ABOUT THIS PAPER

DRAINAGE OF IRRIGATED LANDS is the ninth in a series of training manuals on irrigation. It discusses the need for drainage in irrigated areas, focussing on drainage at the farm level. It reviews the systems that are available to drain irrigated lands and explains which factors of soils and hydrology influence drainage. It touches briefly upon the design, construction, operation, and management of field drainage systems.

ACKNOWLEDGEMENTS

The theory in this manual is based on the second, completely revised edition of ILRI Publication 16: *Drainage Principles and Applications*.

Contents

	Page
Chapter 1 INTRODUCTION	1
Chapter 2 DRAINAGE AND CROP PRODUCTION	3
The need for drainage	3
Drainage to control ponding	7
Drainage to control waterlogging	7
Drainage to control salinization	7
Benefits of drainage	9
Chapter 3 DRAINAGE SYSTEMS	11
Components of a drainage system	11
Field drainage systems	13
Surface drainage systems	15
Subsurface drainage systems	19
Combined drainage systems	21
Chapter 4 FACTORS RELATED TO DRAINAGE	25
Drainage requirement	25
The water table	27
Depth to the water table	27
Dissolved salts in the groundwater	31
Measuring groundwater salinity	31
Hydraulic conductivity	33
Topography	35
Impermeable layers	36
Chapter 5 DESIGN CONSIDERATIONS	37
Drainage as part of an agricultural development project	37
Layout of field drainage systems	37
Surface and subsurface drainage systems	38
Outlet of a field drainage system	40
Design discharge	41
Slopes of field drains	41

	Page
Chapter 6 SURFACE DRAINAGE SYSTEMS	43
Land forming	43
Bedding	43
Land grading and land planing	43
Field drains	49
Design of surface drains	49
Construction of surface drains	50
Chapter 7 SUBSURFACE DRAINAGE SYSTEMS	51
Types of subsurface drainage systems	51
Design of subsurface drainage systems	53
Depth and spacing of field drains	53
Pipes	53
Envelopes	53
Construction of pipe drainage systems	54
Construction methods	54
Alignment and levels	55
Machinery	59
Supervision and inspection	61
Chapter 8 OPERATION AND MAINTENANCE	63
"As-built" data of drainage works	63
Monitoring	63
Maintenance	69
Land surface	69
Open drains	69
Pipe drains	69
Structures	71
SUGGESTED FURTHER READING	73

List of Figures

	Page
1 Drainage can reduce or eliminate (a) waterlogging and/or (b) salinity	2
2 Water balance in an irrigated area	4
3 After irrigation or rainfall, the water table may rise and reach the root zone	5
4 Irrigation water brings salts into the soil	5
5 Surface drainage to remove excess water from the land surface	6
6 Subsurface drainage to control the water table and to remove excess water from the root zone	8
7 Extra irrigation water is applied to remove salts from the root zone	8
8 Components of a drainage system	12
9 A main drain is often a canalized stream	13
10 A gravity outlet structure: the gates are (A) closed during high tide and (B) open during low tide	14
11 A field drain for surface drainage	15
12 Field drains for subsurface drainage may be (A) open drains or (B) pipe drains	16
13 A bedding system	17
14 Land grading for surface drainage means forming the land surface to predetermined grades	18
15 Land planing for surface drainage is the process of smoothing the land surface	18
16 A random field drainage system	18
17 A parallel field drainage system	20
18 In a singular pipe drainage system, the pipe drains discharge into an open collector drain	20
19 In a composite system, the collector drain is also a buried pipe	21
20 Three lay-outs for a subsurface drainage system: (A) Random system; (B) Parallel grid system; (C) Herringbone system	22
21 In the Nile Delta, Egypt, rice is cultivated alongside "dry-foot" crops	23
22 Components of the water balance in an irrigated area	26
23 The water table, the saturated zone below the water table, and the unsaturated zone above the water table	26
24 Fluctuating water table due to recharge by (A) irrigation or (B) rainfall	28
25 Wells to observe the water table: (A) auger hole in stable soil; (B) cased well in unstable soil	29
26 Various ways of measuring depth to water levels in observation wells	30
27 Staff gauge to measure the water level in an open drain	30
28 Example of a pre-printed form for recording water table levels	32
29 Salinization of non-irrigated plots in The Fayoum, Egypt	33
30 Equipment used to measure the hydraulic conductivity with the auger-hole method	34
31 Topographic map of an irrigated area	35
32 Different groundwater conditions: (A) unconfined (water table, phreatic) conditions; (B) confined (artesian) conditions; (C) semi-confined conditions	36

	Page
33 Solving the drainage problem: a farmer and an engineer discussing the design of a drainage system	37
34 Layout of a field drainage system	38
35 The type of drainage system depends on the kind of drainage problem which is faced	39
36 Mole plough attached to a tractor	40
37 For the field drainage system, the drainage base is the water level in the collector drain: (A) free outflow conditions; (B) restricted outflow conditions	40
38 Construction of a bedding system	44
39 Non-uniform land grading for drainage compared with uniform grading for irrigation	44
40 Recommended row length in relation to slope and erodibility of soils	45
41 Sheet flow will easily result in erosion	46
42 Land levelling; final smoothing is done during the first irrigation	46
43 Steps in grading operations	47
44 Types of passable field and collector drains	48
45 A pipe connection between a field and a collector	48
46 Construction of a field drain	50
47 An excavator is used to construct a collector drain	50
48 Input factors for the calculation of drain spacings	52
49 Different types of pipe drains	52
50 Gravel envelope around a pipe drain	54
51 A pre-wrapped envelope	55
52 Steps in the construction of a subsurface drainage system	56
53 Setting out levels for drain pipe installation	57
54 Grade control by laser for drain pipe installation	57
55 Trencher drainage machine	58
56 Trenchless drainage machine: the vertical plough	58
57 Trenchless drainage machine: the V-plough	59
58 Inspection during installation is essential	60
59 For operation and maintenance, a map showing the "as-built" data of the drainage works is required	64
60 A drain should be discharging shortly after rain or irrigation	66
61 Testing the performance of a collector drain by comparing the water levels in the manholes	67
62 Wet spots on the land surface are signs of waterlogging	67
63 In a monitoring and evaluation programme, data on crop yields are collected	68
64 Maintenance of the land surface by animal traction	69
65 Maintenance of open drains should be done before the drainage season	70
66 Flushing machines are used to clean pipe drains	70
67 Scouring and sedimentation in a drop structure after a high discharge	71
68 Good maintenance benefits the farmers	72

Chapter 1

Introduction

In many irrigation projects, crop yields are reduced due to waterlogging and salinization of the land. In some cases, there is total loss of production and therefore the land is abandoned. Waterlogging may also cause human health problems, particularly malaria, because of ponded water. Of the estimated 235 million ha of irrigated land in the world, 10 to 15 percent has been affected by waterlogging and salinization.

Two important causes of waterlogging and salinization are: (a) excessive application of irrigation water; and (b) lack of adequate drainage. Thus provision of adequate drainage is a solution to the waterlogging and salinization problems of irrigated lands. However, it must be pointed out that improving drainage should not be a substitute for reducing excessive application and that improved drainage should not be implemented without first assessing whether waterlogging may be reduced by optimizing application. Figure 1 (a and b) illustrates waterlogging and salinization of irrigated lands respectively.

This manual will help extension officers and irrigation technicians to understand the relationship between irrigation and drainage. It will show them how to assess the need for drainage, and will help them understand how drainage systems function.

Chapter 2 presents the importance of drainage in crop production. It shows the need to control waterlogging and salinization and how this could be achieved by drainage.

Chapter 3 deals with the physical features of the drainage system. It explains the components of a typical drainage system. It also describes the different types of drainage systems and their appropriate applications.

Chapter 4 discusses the factors related to drainage, a good understanding of which is essential to design, construct and manage a drainage system. It also presents simple methods to determine the depth of the water table and hydraulic conductivity of soils which are important factors in the design of drainage systems.

Chapter 5 is concerned with drainage design considerations. It explains the layout of surface and subsurface drainage systems and the needs and requirements of drainage outlets.

Chapters 6 and 7 deal with the design and construction of surface and subsurface drainage systems respectively. In Chapter 7, special attention is given to the design, installation and supervision of construction of pipe-drainage systems.

Chapter 8 deals with operation, monitoring and maintenance of drainage systems.

The intention of the manual is to present a complete picture of drainage of irrigated lands in a simple form. Those who wish to obtain additional information are referred to the reading list suggested at the end of the manual.

FIGURE 1
Drainage can reduce or eliminate (a) waterlogging and/or (b) salinity



Chapter 2

Drainage and crop production

THE NEED FOR DRAINAGE

Figure 2 shows the water balance in an irrigated area. Before irrigation water can be applied to a crop, it has to be diverted from a river or lake (1) or pumped from the groundwater reservoir (2). The amount of water needed has to be greater than the quantity required by the crop because some of it will leave the area in various ways: not only will it be used by the crop as evapotranspiration (3), but some of it will be lost as evaporation (4), as seepage (5) and operational spills (6) from the irrigation canal system, as tailwater runoff from irrigated fields (7), and as deep percolation (8).

In the field, irrigation water, together with any rainfall (9), will be partly stored on the soil surface (10) and will partly infiltrate into the soil (11). If rain or irrigation continues for long periods, pools may form on the soil surface. This excess water on the soil surface is called ponded water. It needs to be removed.

Ponding is the accumulation of excess water on the soil surface.

Part of the water that infiltrates into the soil will be stored in the soil pores and will be used by the crop (3); another part of the water will be lost as deep percolation (8). When the percolating water reaches that part of the soil which is saturated with water, it will cause the water table to rise (12). If the water table reaches the root zone, the plants may suffer (Figure 3). The soil has become waterlogged. Drainage is needed to remove the excess water and stop the rise of the water table.

Waterlogging is the accumulation of excess water in the root zone of the soil.

Even if irrigation water is of very good quality, it will contain some salts. So, bringing irrigation water to a field also means bringing salts to that field. The irrigation water is used by the crop or evaporates directly from the soil. The salts, however, are left behind (Figure 4). This process is called salinization. If these salts accumulate in the soil, they will hamper the growth of crops.

Salinization is the accumulation of soluble salts at the soil surface, or at some point below the soil surface, to levels that have negative effects on plant growth and/or on soils.

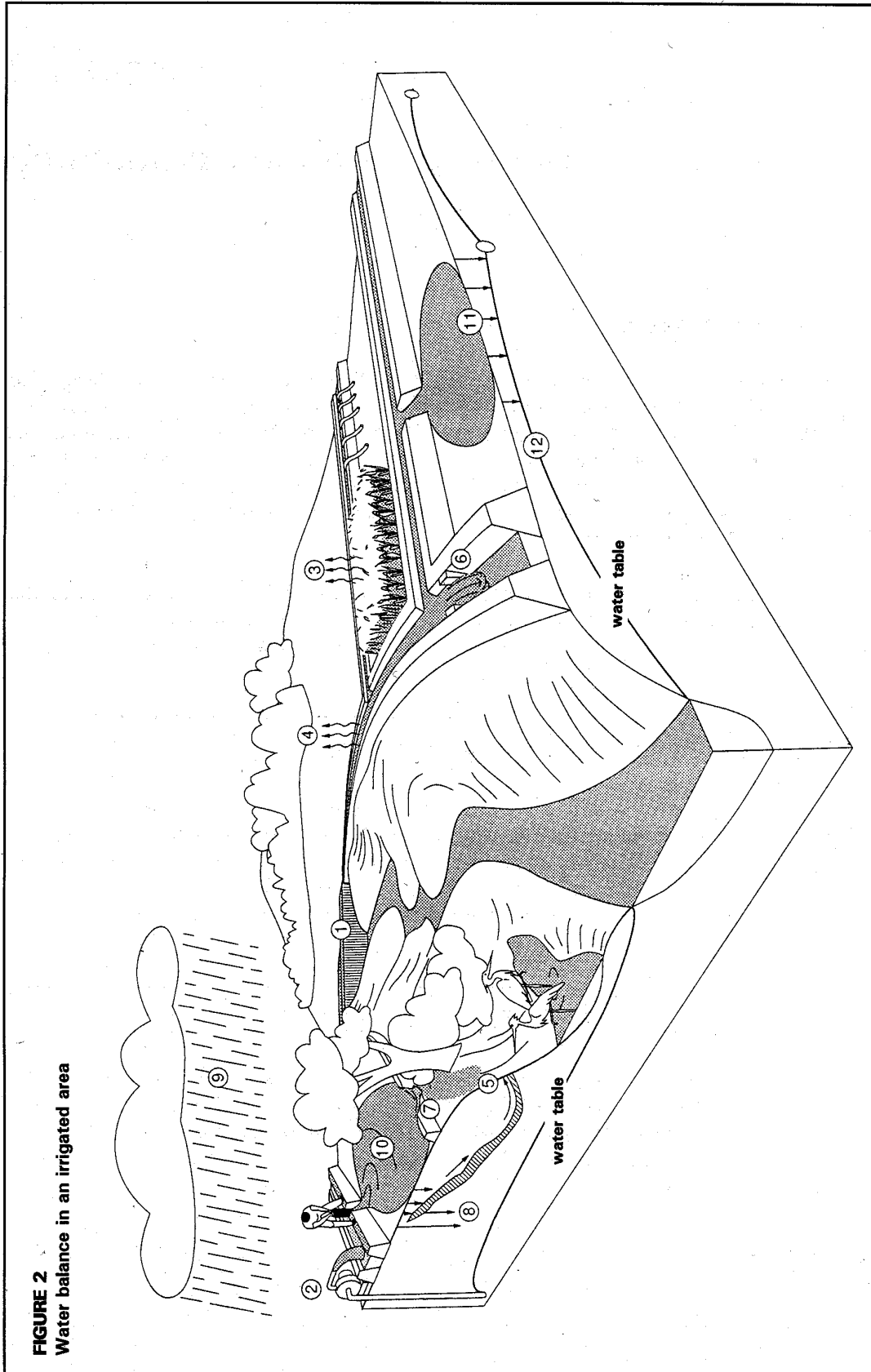

FIGURE 2
Water balance in an irrigated area

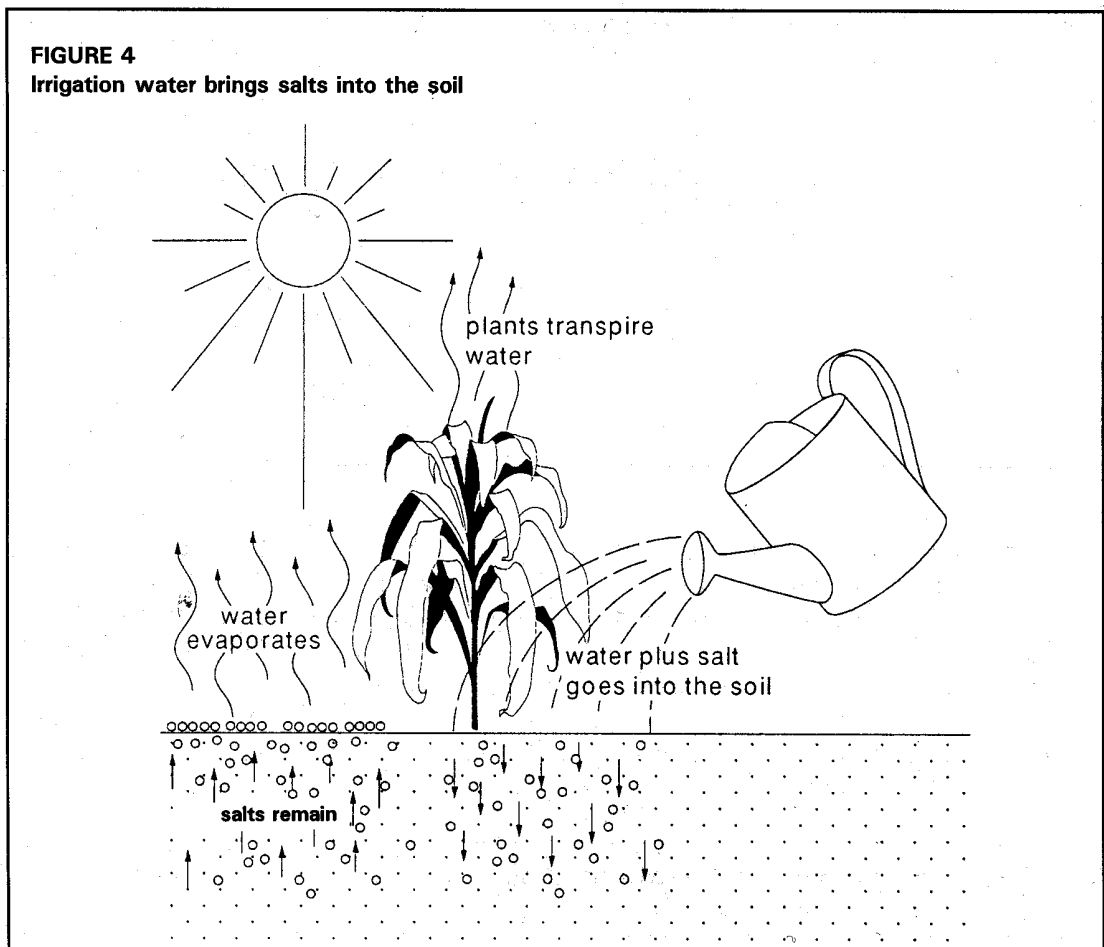
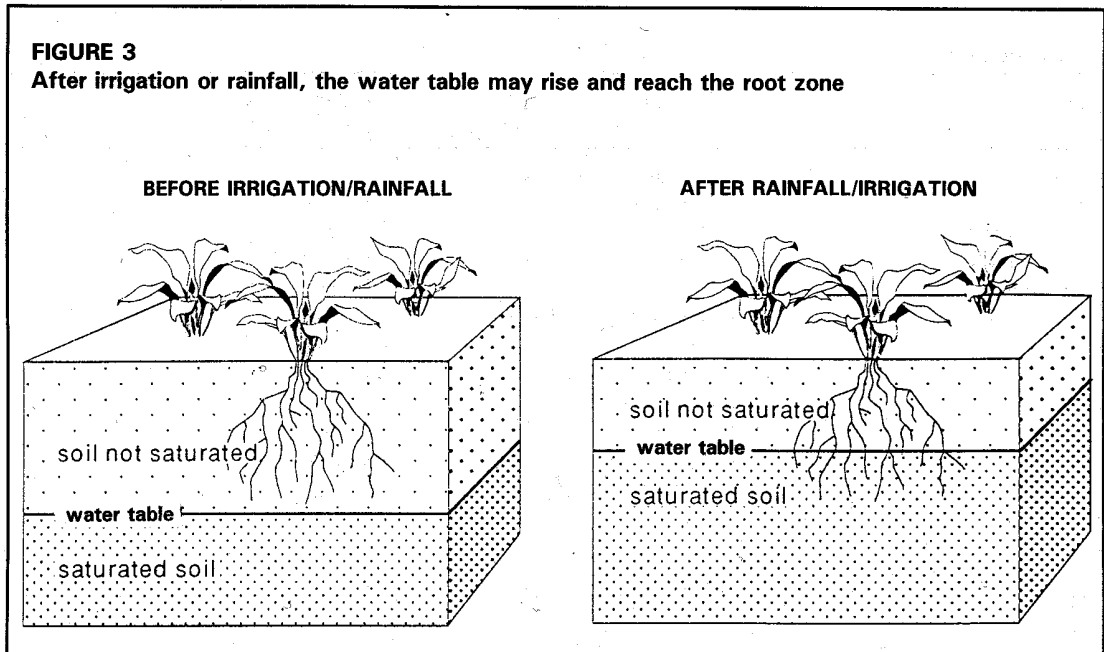
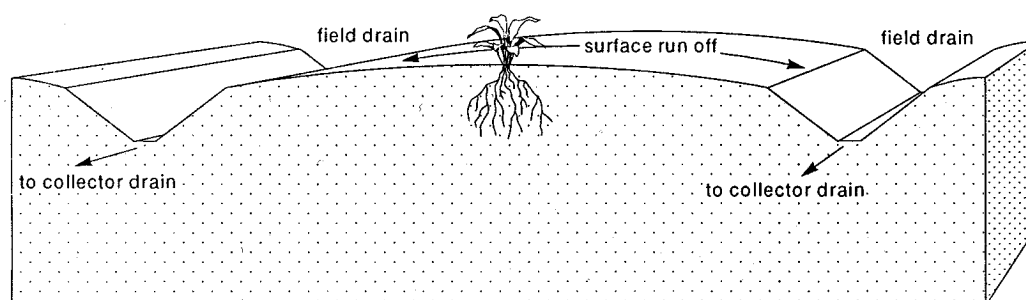

TABLE 1
Tolerance levels of some of the major crops

Highly tolerant (up to 10 g/l)	Moderately tolerant (up to 5 g/l)	Sensitive (up to 2.5 g/l)
Date palm Barley Sugar beet Asparagus Spinach	Wheat Tomato Oats Alfalfa Rice Maize Flax Potato Carrot Onion Cucumber Pomegranate Fig Olive Grape	Red clover Peas Beans Sugar cane Pear Apple Orange Prune Plum Almond Apricot Peach

FIGURE 5
Surface drainage to remove excess water from the land surface



Some crops are more tolerant to salts than others (Table 1). Highly tolerant crops can withstand a salt concentration up to 10 g/l in the saturation extract. Moderately tolerant crops can withstand up to 5 g/l, and sensitive crops up to 2.5 g/l. (For more information, see Training Manual No. 1 *Introduction to Irrigation*.) If sensitive crops are to be grown, drainage is needed to remove the salts.

So, drainage is used to control ponding at the soil surface, to control waterlogging in the soil, and to avoid salinization.

Drainage is the removal of excess water and dissolved salts from the surface and subsurface of the land in order to enhance crop growth.

Drainage can be either natural or artificial. Most areas have some natural drainage; this means that excess water flows from the farmers' fields to swamps or to lakes and rivers. Sometimes, however, the natural drainage is inadequate to remove the extra water or salts brought in by irrigation. In such a case, an artificial or man-made drainage system is required.

A man-made drainage system is an artificial system of surface drains and/or subsurface drains, related structures, and pumps (if any) to remove excess water from an area.

Therefore drainage is needed for successful irrigated agriculture because it controls ponding, waterlogging and salinity.

DRAINAGE TO CONTROL PONDING

To remove ponding water from the surface of the land, surface drainage is used. Normally, this consists of digging shallow open drains. To make it easier for the excess water to flow towards these drains, the field is given an artificial slope. This is known as land shaping or grading (Figure 5).

Surface drainage is the removal of excess water from the surface of the land by diverting it into improved natural or constructed drains, supplemented, when necessary, by the shaping and grading of the land surface towards such drains.

DRAINAGE TO CONTROL WATERLOGGING

To remove excess water from the root zone, subsurface drainage is used (Figure 6). This is done by digging open drains or installing pipes, at depths varying from 1 to 3 m. The excess water then flows down through the soil into these drains or pipes. In this way, the water table can be controlled.

Subsurface drainage is the removal of excess water and dissolved salts from soils via groundwater flow to the drains, so that the water table and root-zone salinity are controlled.

DRAINAGE TO CONTROL SALINIZATION

To remove salts from the soil, more irrigation water is applied to the field than the crops require. This extra water infiltrates into the soil and percolates through the root zone. While the water is percolating, it dissolves the salts in the soil and removes them through the subsurface drains (Figure 7). This process, in which the water washes the salts out of the root zone, is called leaching.

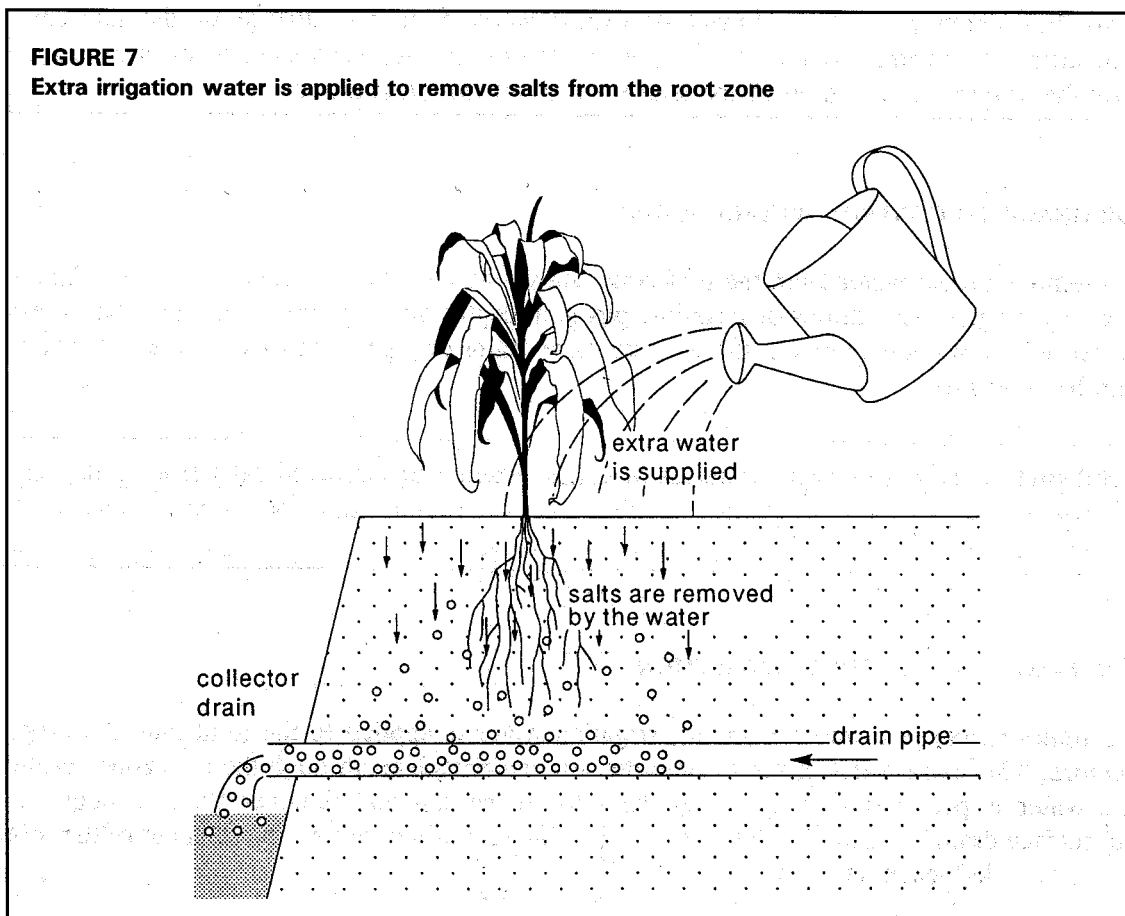
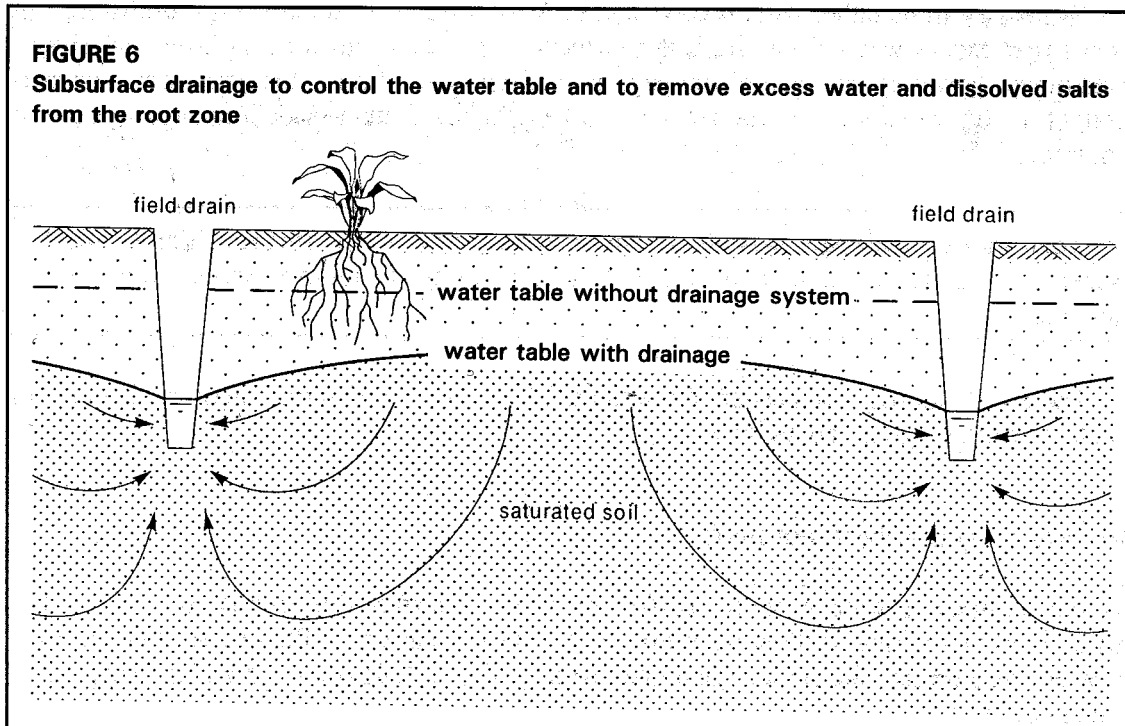

Leaching is the removal of soluble salts by water percolating through the soil.

The extra water required for leaching must be removed from the root zone by drainage, otherwise the water table will rise and this will bring the salts back into the root zone. Therefore salinity is controlled by a combination of irrigation and drainage.

BENEFITS OF DRAINAGE

One of the benefits of installing a drainage system to remove excess water is that the soil is better aerated. This leads to a higher productivity of crop land or grassland because:

- The crops can root more deeply.
- The choice of crops is greater.
- There will be fewer weeds.
- Fertilizers will be used more efficiently.
- There will be less denitrification.
- The grass swards will be better.

Other benefits of well-drained soils are:

- The land is more easily accessible.
- The land has a greater bearing capacity.
- The soil has a better workability and tilth.
- The period in which tillage operations can take place is longer.
- The activity of micro-fauna (e.g. earthworms) is increased, which improves permeability.
- The soil structure is better, which also improves permeability.
- Soil temperatures are higher, so that crops (particularly horticultural crops) and grasses can be grown earlier.

When drainage makes it possible to control the water table, the benefits that follow are:

- The root zone cannot become salinized by the capillary rise of saline groundwater.
- Leaching is made possible.

In its turn, the benefits of leaching are:

- It prevents increases in soil salinity in the root zone, thus making irrigated land use sustainable in the long term.
- By removing salts, it allows salt-sensitive crops, or a wider range of crops, to be grown.
- It makes it possible to reclaim salt-affected soils, thus bringing new land into cultivation.

Chapter 3

Drainage systems

COMPONENTS OF A DRAINAGE SYSTEM

As shown in Figure 8, a drainage system has three components:

- A field drainage system, which prevents ponding water on the field and/or controls the water table.
- A main drainage system, which conveys the water away from the farm.
- An outlet, which is the point where the drainage water is led out of the area.

The **field drainage system** is a network that gathers the excess water from the land by means of field drains, possibly supplemented by measures to promote the flow of water to these drains.

The field drainage system is the most important component for the farmers. More details on field drainage systems are given in the following section.

The **main drainage system** is a water-conveyance system that receives water from the field drainage systems, surface runoff and groundwater flow, and transports it to the outlet point.

The main drainage system consists of some collector drains and a main drainage canal. A collector drain collects water from the field drains and carries it to the main drain for disposal. Collector drains can be either open drains or pipe drains.

The main drain is the principal drain of an area. It receives water from collector drains, diversion drains, or interceptor drains (= drains intercepting surface flow or groundwater flow from outside the area), and conveys this water to an outlet for disposal outside the area. The main drain is often a canalized stream (i.e. an improved natural stream), which runs through the lowest parts of the agricultural area (Figure 9).

The **outlet** is the terminal point of the entire drainage system, from where the drainage water is discharged into a river, a lake, or a sea.

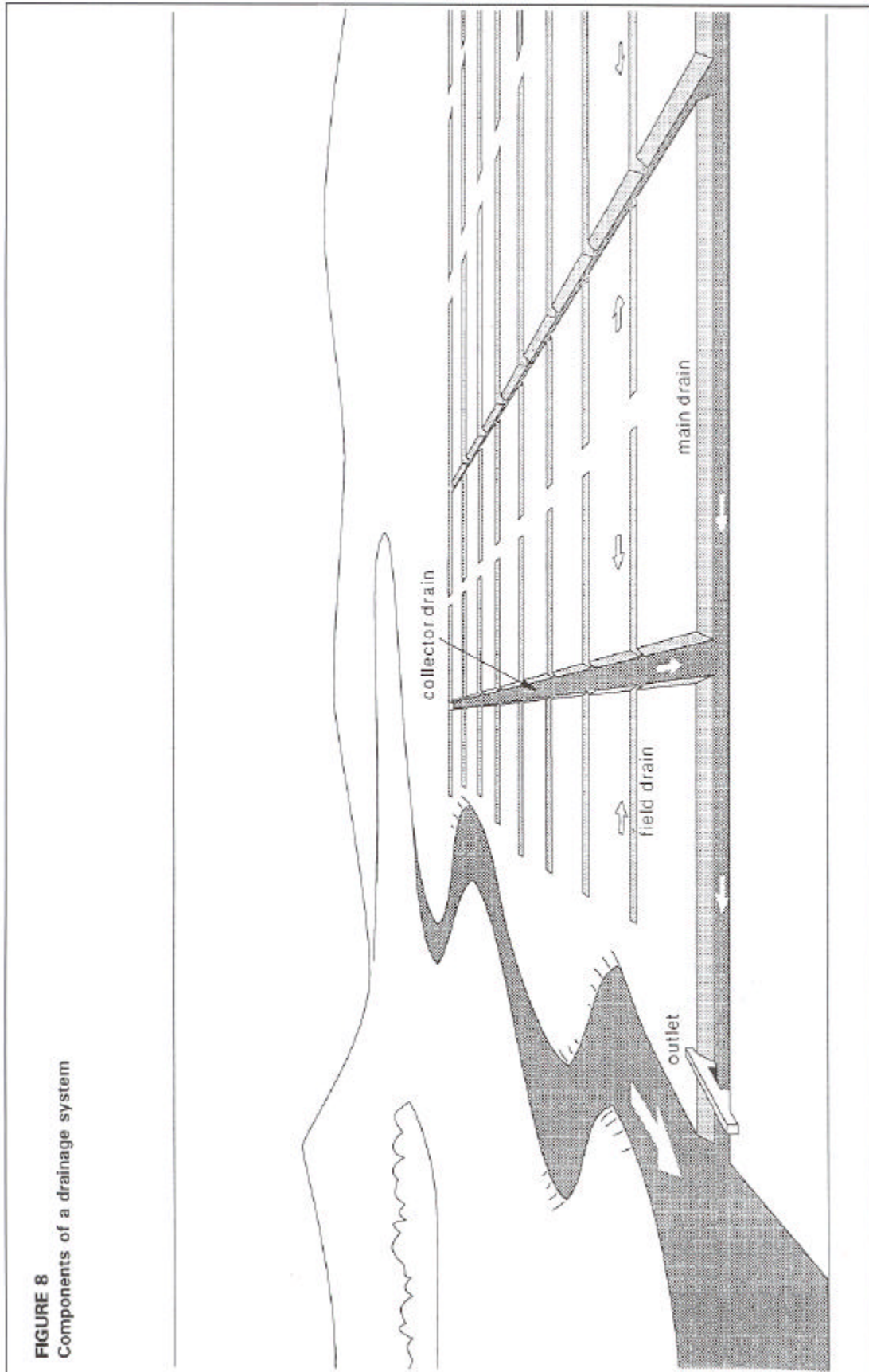

FIGURE 9
A main drain is often a canalized stream



An outlet can be one of two kinds: a gravity outlet or a pumping station. A gravity outlet is a drainage structure in an area which has outside water levels that rise and fall. There, the drainage water can flow out when the outside water levels are low (Figure 10). In delta areas, drainage by gravity is only possible for a few hours a day when tides are low. In the upstream regions of a river, drainage by gravity might not be possible for several weeks, during periods when river levels are high.

A pumping station is needed in areas where the water levels in the drainage system are lower than the water level of the river, lake or sea.

FIELD DRAINAGE SYSTEMS

A field drainage system can be a surface drainage system (to remove excess water from the surface of the land) or a subsurface drainage system (to control the water table in the soil). In surface drainage, field drains are shallow graded channels, usually with relatively flat side slopes (Figure 11).

In subsurface drainage, field drains can be either open drains or pipe drains. Open drains and pipe drains have the same function. The difference between them is the way they are constructed: an open drain is an excavated ditch with an exposed water table (Figure 12A); a pipe drain is a buried pipe (Figure 12B).

FIGURE 10

A gravity outlet structure: the gates are (A) closed during high tide and (B) open during low tide

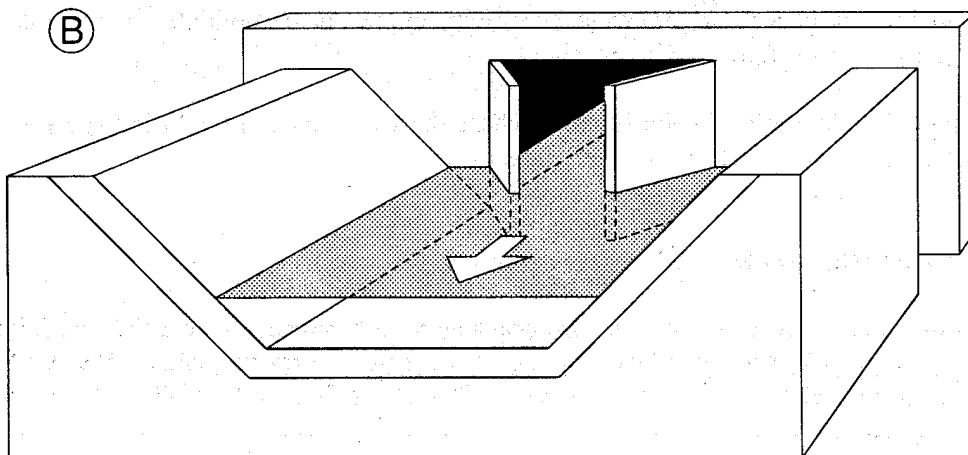
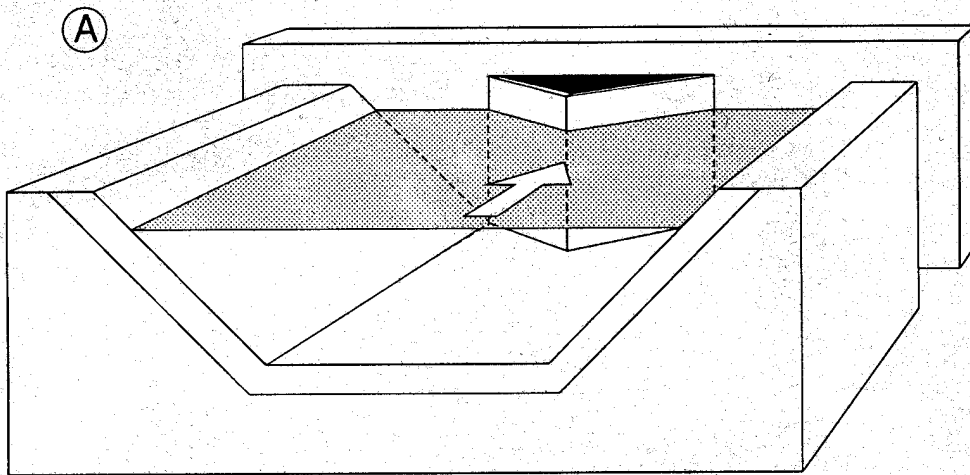



Surface drainage systems

A surface drainage system always has two components:

- Open field drains to collect the ponding water and divert it to the collector drain.
- Land forming to enhance the flow of water towards the field drains.

A surface drainage system is a system of drainage measures, such as open drains and land forming, to prevent ponding by diverting excess surface water to a collector drain.

FIGURE 12
Field drains for subsurface drainage may be (A) open drains or (B) pipe drains

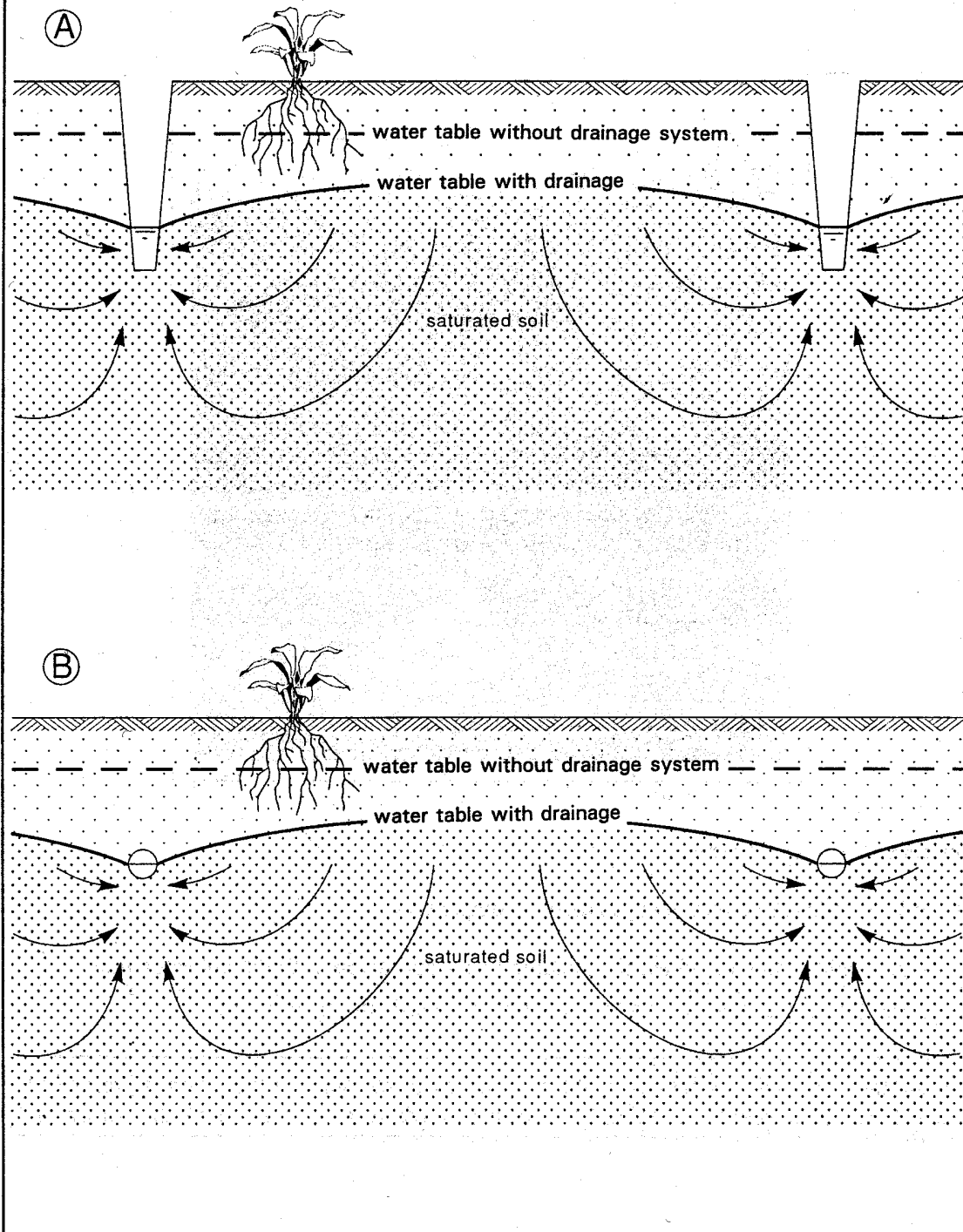

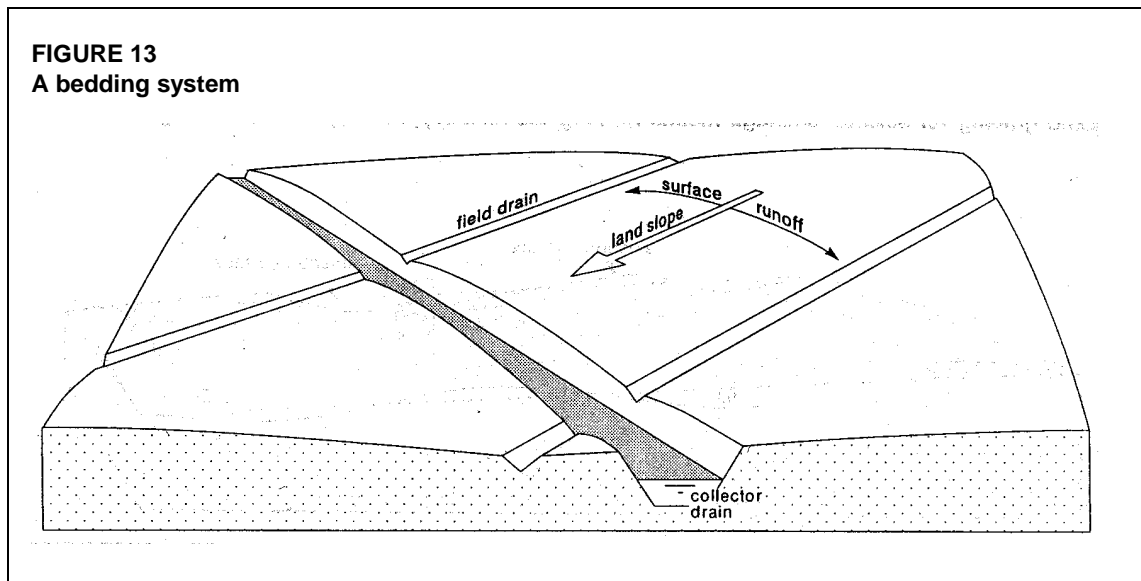

Land forming means changing the surface of the land to meet the requirements of surface drainage or irrigation. There are three land-forming systems: bedding, land grading and land planing.

Bedding

Bedding is the oldest surface drainage practice. With this system, the land surface is formed into beds. This work can be done by manual labour, animal traction, or farm tractors. The beds are separated by parallel shallow, open field drains, oriented in the direction of the greatest land slope (Figure 13). The water drains from the beds into the field drains, which discharge into a collector drain constructed at the lower end of the field and at right angles to the field drains.

Bedding is a surface drainage method achieved by ploughing land to form a series of low beds, separated by parallel field drains.

The bedding system is normally used for grassland. In modern farming, bedding is not considered an acceptable drainage practice for row crops, because rows near the field drains will not drain satisfactorily. To overcome the disadvantages of the bedding system, the two other methods of land forming have been developed: land grading and land planing.

Land grading

Land grading for surface drainage consists of forming the land surface by cutting, filling and smoothing it to predetermined grades, so that each row or surface slopes to a field drain (Figure 14). It is a one-time operation.

Land grading for surface drainage differs from land levelling for irrigation in that, for drainage, the grades need not be uniform. They can be varied as much as is needed to provide drainage with the least amount of earthmoving.

FIGURE 14

Land grading for surface drainage means forming the land surface to predetermined grades

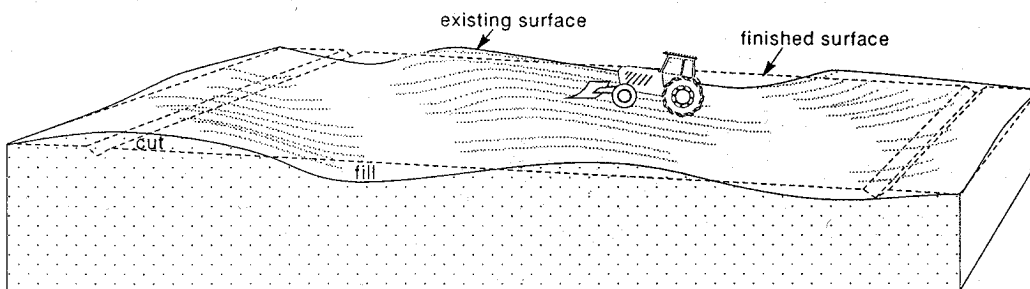
**FIGURE 15**

Land planing for surface drainage is the process of smoothing the land surface

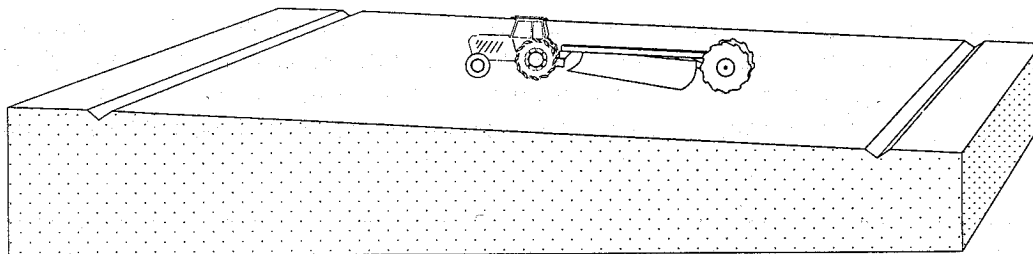
**FIGURE 16**

A random field drainage system

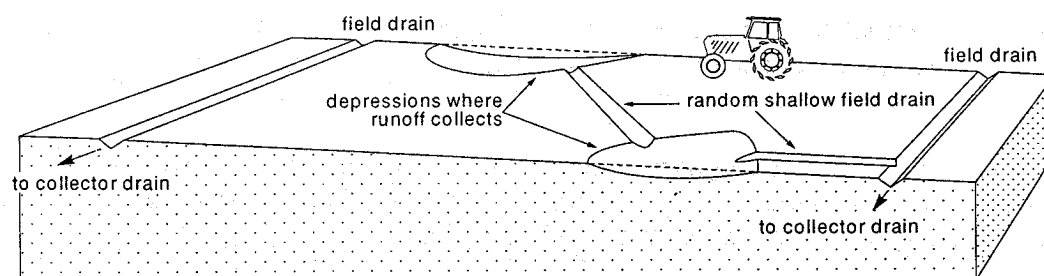

Land grading is forming the surface of the land to predetermined grades, so that each row or surface slopes to a field drain.

Compared with bedding, land grading reduces the number of field drains, thus reducing the need for weed control and maintenance. Land grading also means that more land is available for use.

Land planing

Land planing is the process of smoothing the land surface to eliminate minor depressions and irregularities, but without changing the general topography (Figure 15). It is often done after land grading, because irregular micro-topography in a flat landscape, in combination with heavy soils, can cause severe crop losses.

Land planing is smoothing the land surface with a land plane to eliminate minor depressions and irregularities without changing the general topography.

In the field, surface drainage systems can have two different layouts: the random field drainage system, and the parallel field drainage system.

Random field drainage system

The random field drainage system is applied where there are a number of large but shallow depressions in a field, but where a complete land-forming operation is not considered necessary. The random field drainage system connects the depressions by means of a field drain and evacuates the water into a collector drain (Figure 16). The system is often applied on land which does not require intensive farming operations (e.g. pasture land) or where mechanization is done with small equipment.

Parallel field drainage system

The parallel field drainage system (Figure 17), in combination with proper land forming, is the most effective method of surface drainage. The parallel field drains collect the surface runoff and discharge it into the collector drain. The spacing between the field drains depends on the size of fields that can be prepared and harvested economically, on the tolerance of crops to ponding, and on the amount and costs of land forming. The system is suitable in flat areas with an irregular micro-topography and where farming operations require fields with regular shapes.

Subsurface drainage systems

A subsurface drainage system is a system for the removal of excess water and dissolved salts from the soil, using the groundwater as a "vehicle".

A **subsurface drainage system** is a man-made system that induces excess water and dissolved salts to flow through the soil to pipes or open drains, from where it can be evacuated.

FIGURE 17
A parallel field drainage system

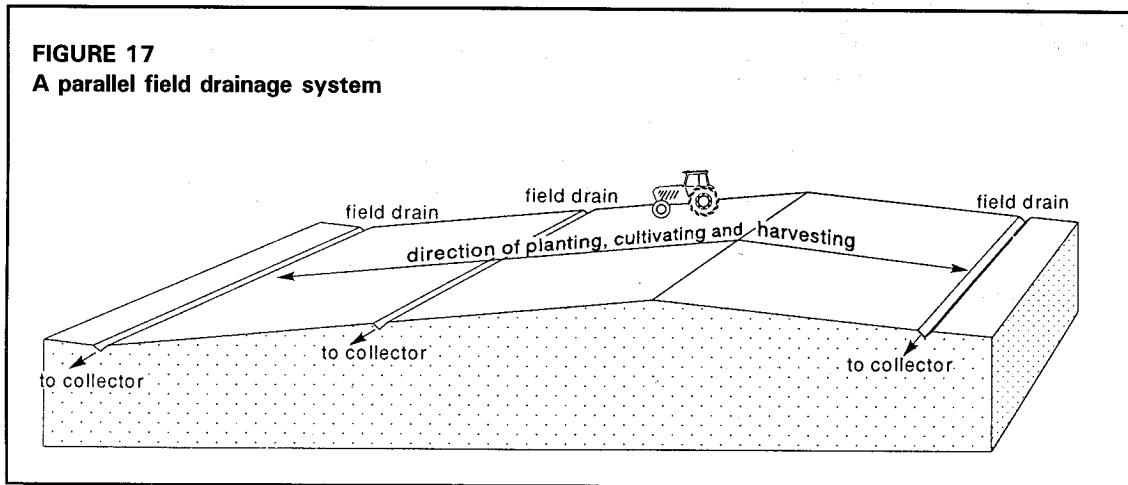

FIGURE 18
In a singular pipe drainage system, the pipe drains discharge into an open collector drain



If it is decided to install a subsurface drainage system, a choice has to be made between open drains or pipe drains. Open drains have the advantage that they can receive overland flow and can thus also serve as surface drainage. The disadvantages are the loss of land, the interference with the irrigation system, the splitting up of the land into small farm blocks, which hampers farming operations, and that they are a maintenance burden.

The choice between open drains or pipe drains has to be made at two levels: for field drains and for collector drains. If the field drains are to be pipes, there are still two options for the collectors:

- open drains, so that there is a singular pipe drainage system;
- pipe drains, so that there is a composite pipe drainage system.

In a singular pipe drainage system, each field pipe drain discharges into an open collector drain (Figure 18).

A **singular drainage system** is a drainage system in which the field drains are buried pipes and all field drains discharge into open collector drains.

In a composite system, the field pipe drains discharge into a pipe collector (Figure 19), which in turn discharges into an open main drain. The collector system itself may be composite, with sub-collectors and a main collector.

A **composite drainage system** is a drainage system in which all field drains and all collector drains are buried pipes.

For subsurface drainage, a distinction can also be made between different types of systems. A random system connects scattered wet spots, often as a composite system (Figure 20A). If the drainage has to be uniform over the whole area, the drains are installed in a regular pattern. This pattern can be either a parallel grid system, in which the field drains join the collector drain at right angles (Figure 20B), or a herringbone system, in which they join at sharp angles (Figure 20C). Both regular patterns may occur as singular or composite systems.

Combined drainage systems

Sometimes, combined surface and subsurface drainage systems are used. Whether this is needed or not depends on a combination of factors: the intensity and duration of the rainfall, surface

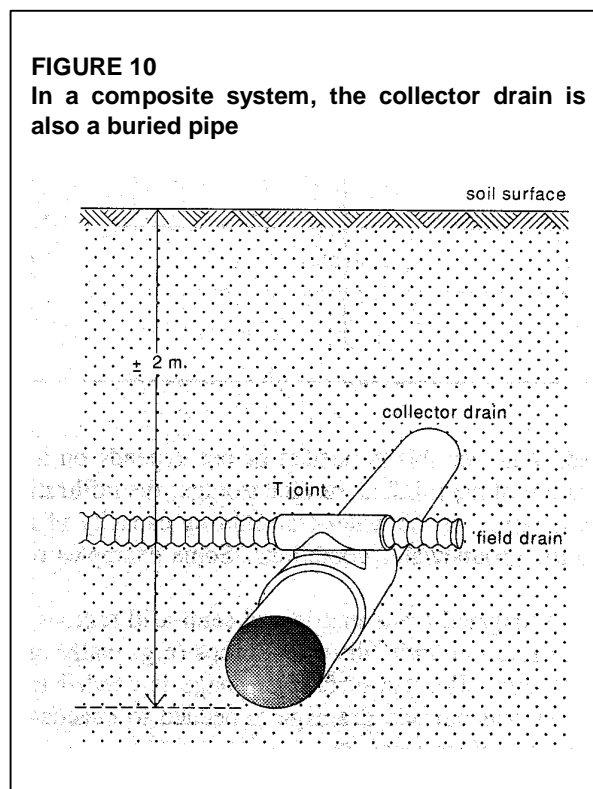

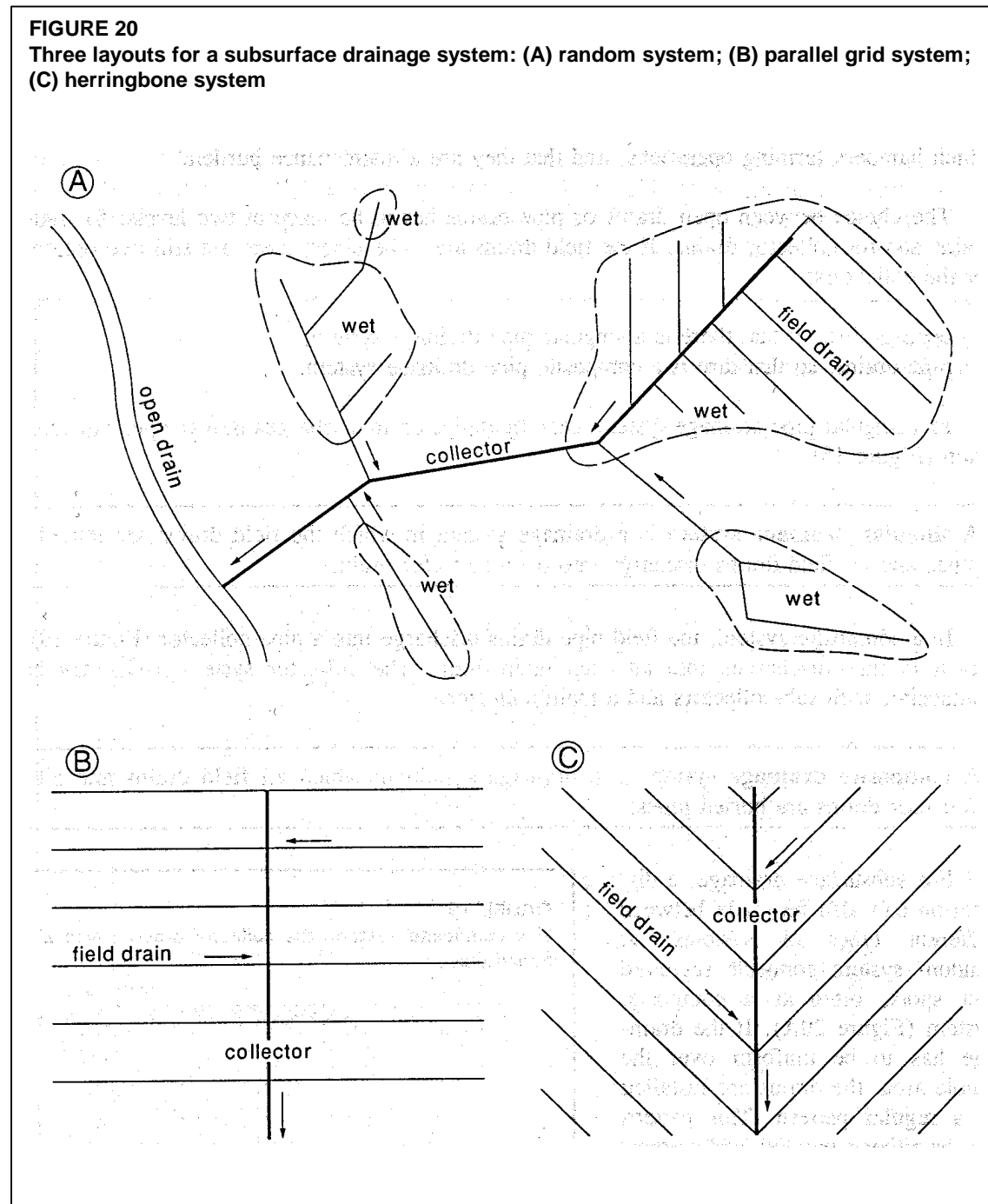

storage, the infiltration rate, the hydraulic conductivity (which is a measure of the water-transmitting capacity of soils, and will be discussed in chapter 4), and the groundwater conditions. Some examples of combined systems are:

- In irrigated areas in arid and semi-arid regions, where the cropping pattern includes rice in rotation with "dry-foot" crops (e.g. maize and cotton), as in the Nile Delta in Egypt (Figure 21). Subsurface drainage is needed to control salinity for the dry-foot crops, whereas surface drainage is needed to evacuate the standing water from the rice fields (e.g. before harvest).

- Areas with occasional high-intensity rainfall (say more than 50 mm/day), which causes water to pond at the soil surface, even when a subsurface drainage system has been installed.

In both of these examples, the standing water could be removed by the subsurface drainage system, but this would either take too long or require drain spacings that are so close as to be economically unjustifiable. In such cases, it is generally more efficient to remove the ponded water by surface drainage.

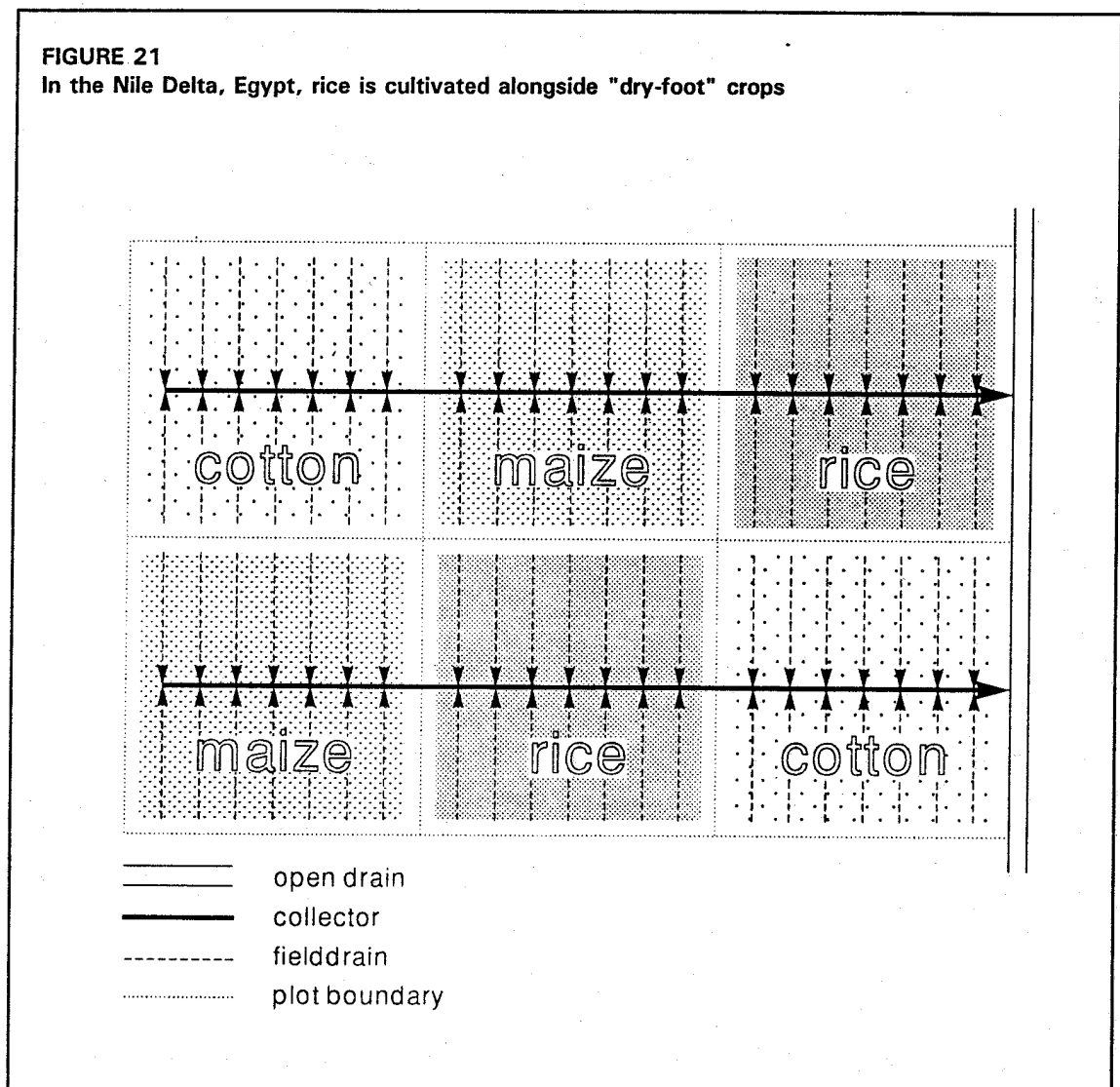

Chapter 4

Factors related to drainage

In Chapter 2, it was shown that when irrigation is introduced into an area, the natural conditions are changed and may need a drainage system. To predict the effects of these changes, the soil and hydrological factors under which the drainage system will have to function need to be known. Some of the most important factors are briefly discussed.

DRAINAGE REQUIREMENT

For the design of a drainage system, the drainage requirement or the drainable surplus has to be known. This is the amount of water that must be removed from an area within a certain period so as to avoid an unacceptable rise in the levels of the groundwater or surface water. Removing the drainable surplus has two advantages:

- It prevents waterlogging by artificially keeping the water table sufficiently deep.
- It removes enough water from the root zone so that any salts brought in by irrigation cannot reach a concentration that would be harmful to crops.

The **drainage requirement** is the amount of water that must be removed from an area within a certain period so as to avoid an unacceptable rise in the levels of the groundwater or surface water.

Calculating the drainage requirement is a major problem in many irrigated areas. The natural conditions in these areas are diverse, and different water resources may be involved in the calculations. Therefore field work has to be carried out to find out what the general features of the groundwater regime are, and the water and salt regimes and their balances have to be studied. A proper understanding of these regimes allows the drainage engineer to predict how they will be affected by drainage.

To calculate the drainage requirement, an analysis has to be made of the overall water balance of the study area (Figure 22). Water balances are often assessed for an average year. Waterlogging and salinity problems, however, are not of the same duration or frequency every year. Therefore there is often a need to assess water balances, not only for an average year, but also for specific years (e.g. a very dry year or a year with extreme rainfall), or even for specific periods (e.g. the growing season or the irrigation season).

FIGURE 22
Components of the water balance in an irrigated area

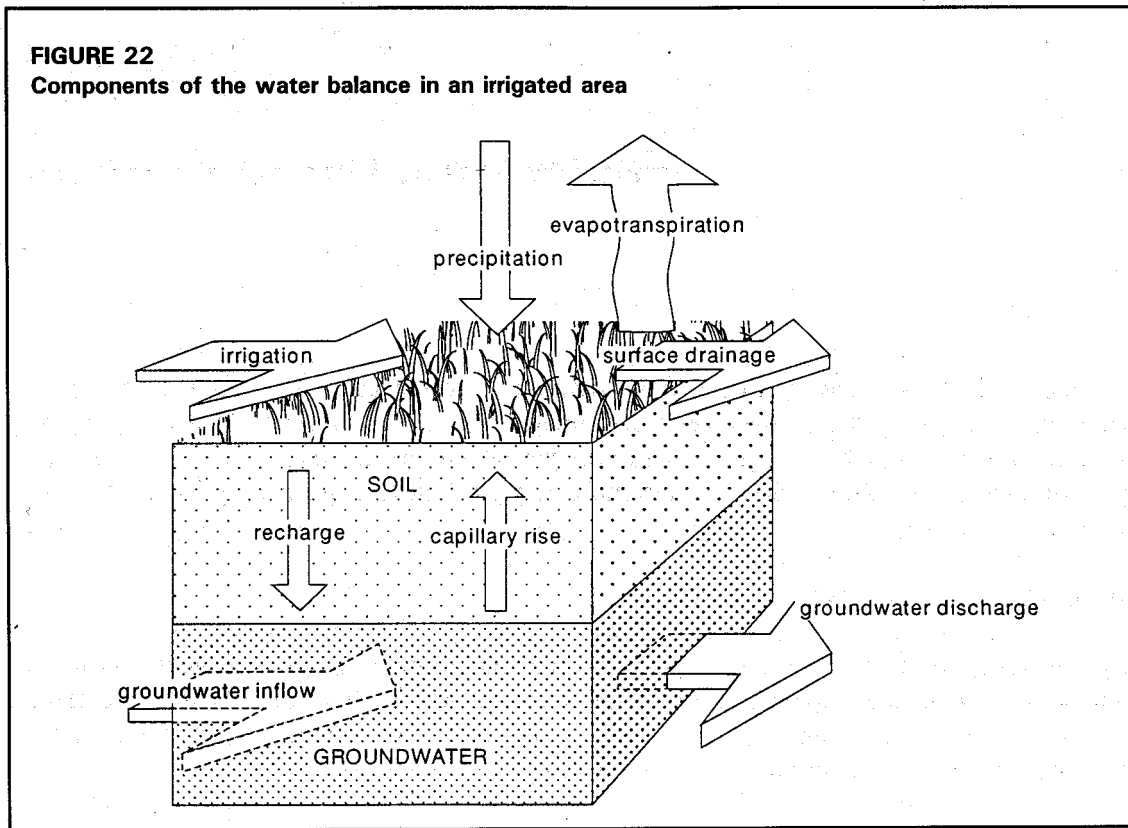
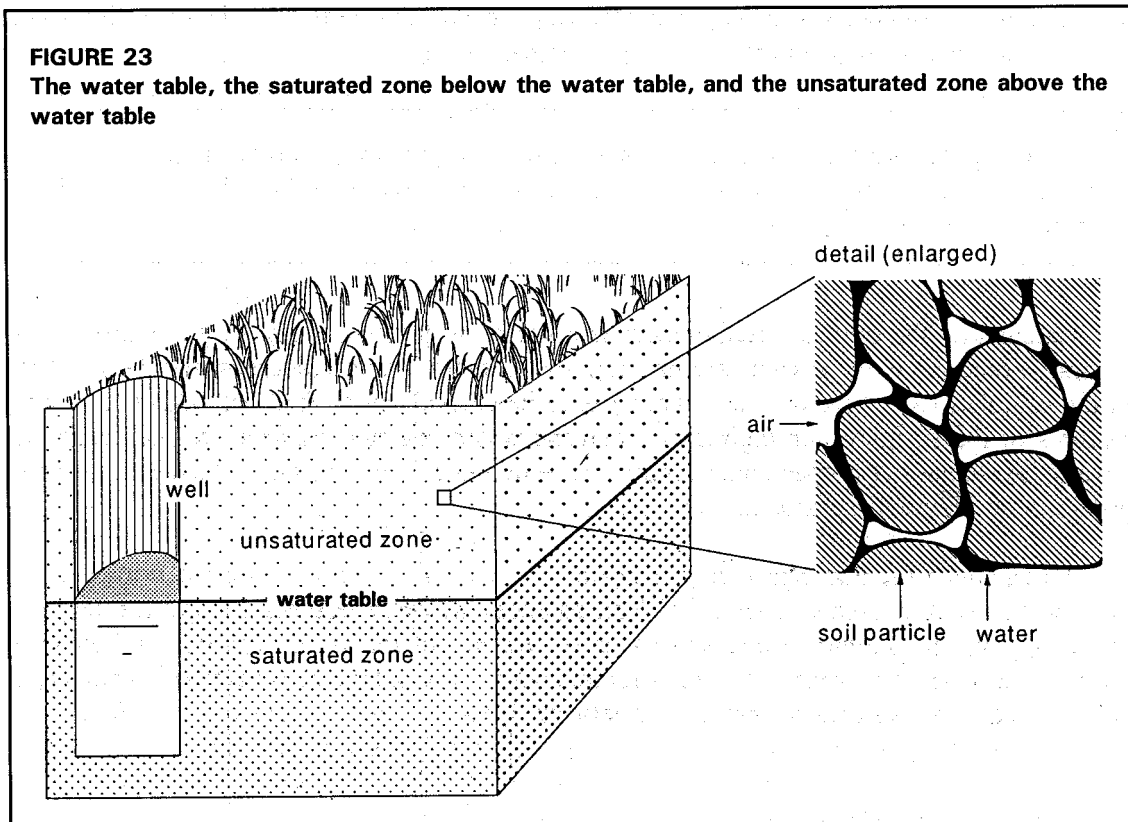

FIGURE 23
The water table, the saturated zone below the water table, and the unsaturated zone above the water table



THE WATER TABLE

The water table is the upper boundary of the groundwater. It is defined as the locus of points at which the pressure in the groundwater is equal to atmospheric pressure.

The **water table** is the locus of points at which the pressure in the groundwater is equal to atmospheric pressure.

Below the water table, all the soil pores are filled with water. This is known as the saturated zone (Figure 23). Most of the flow of groundwater towards the drains takes place in the saturated zone. Above the water table, there is a zone where the soil pores are filled partly with water and partly with air. This is the unsaturated zone. Water in the unsaturated zone originates from rain or irrigation water that has infiltrated into the soil, and from the capillary rise of groundwater. The unsaturated zone is very important for plant growth. This is the zone where roots take up water.

The water table fluctuates with time. After irrigation or rainfall, there is a sudden rise of the water table, followed by a gradual fall due to the flow of water towards the drainage system (Figure 24).

DEPTH TO THE WATER TABLE

The depth to the water table is measured in observation wells (Figure 25). An observation well is a small-diameter plastic pipe ($> \varnothing 12$ mm), placed in the soil. The pipe is perforated over a length that the water table is expected to fluctuate. Sometimes a gravel filter is placed around the pipe to ease the flow of water and to prevent the perforations from becoming clogged by fine particles like clay and silt. In stable soils (e.g. heavy clay soils), simply an auger hole can be made in the ground and no pipe is needed (Figure 25A).

Water levels can be measured in various ways (Figure 26):

- The wetted tape method (Figure 26A): A steel tape (calibrated in millimetres), with a weight attached to it, is lowered into the pipe or auger hole to below the water level. The lowered length of tape from the reference point (e.g. the top of the pipe) is noted. The tape is then pulled up and the length of its wetted part is measured. (This is easier to see if the lower part of the tape is chalked.) The depth to the water level from the reference point is obtained by subtracting the wetted length from the total lowered length.
- With a mechanical sounder (Figure 26B): This consists of a small steel or copper tube (10 to 20 mm in diameter and 50 to 70 mm long), which is closed at its upper end, open at its bottom end, and connected to a calibrated steel tape. When lowered into the pipe, it produces a characteristic plopping sound upon hitting the water. The depth to the water level can be read directly from the steel tape.
- With an electric water-level indicator (Figure 26C): This consists of a double electric wire with electrodes at their lower ends. The upper ends of the wire are connected to a battery and an indicator device (lamp, amp meter, sounder). When the wire is lowered

FIGURE 24
Fluctuating water table due to recharge by (A) irrigation or (B) rainfall

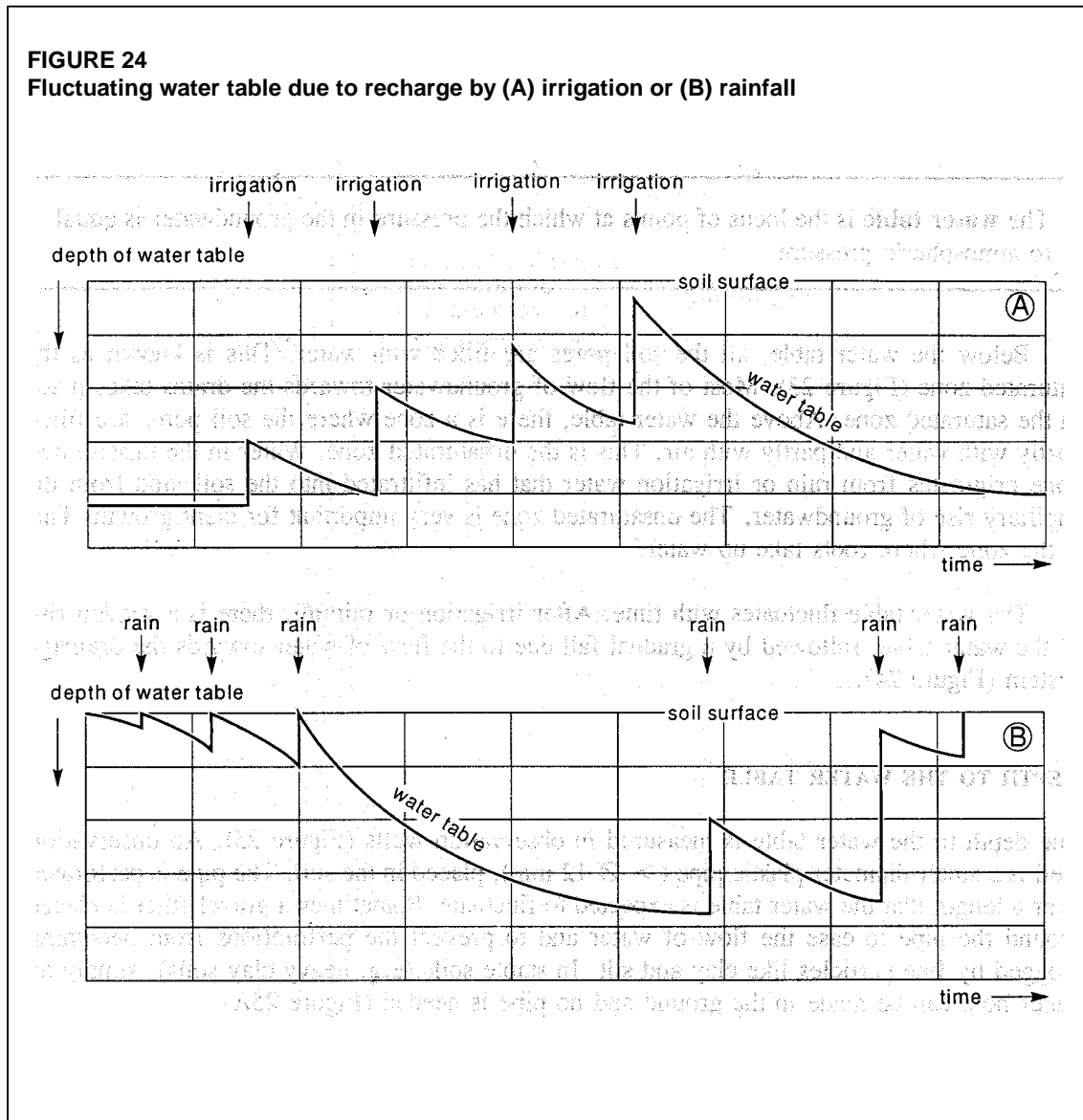

into the pipe and the electrodes touch the water, the electrical circuit closes, which is shown by the indicator. If the wire is attached to a calibrated steel tape, the depth to the water level can be read directly.

- With a floating level indicator or recorder (Figure 26D): This consists of a float (60 to 150 mm in diameter) and a counterweight attached to an indicator or recorder. Recorders can generally be set for different lengths of observation period. They require relatively large pipes. The water levels are either drawn on a rotating drum or punched into a paper tape.
- With a pressure logger or electronic water-level logger (Figure 26E): This measures and records the water pressure at one-hour intervals over a year. The pressure recordings are controlled by a microcomputer and stored in an internal, removable memory block. At the end of the observation period or when the memory block has reached capacity, it is removed and replaced. The recorded data are read by a personal computer. Depending

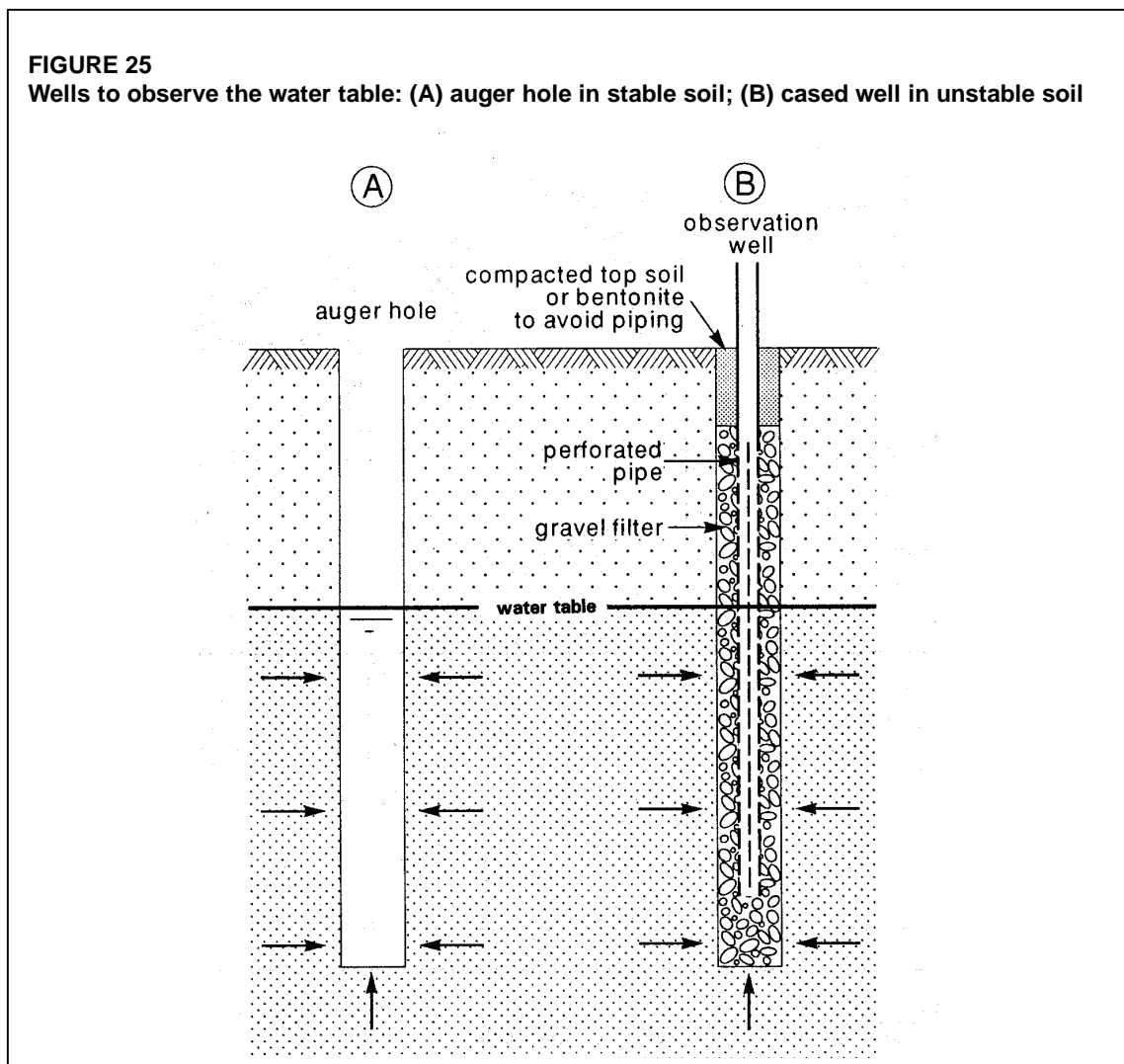

on the additional software chosen, the results can be presented raw or in a calculated form. Pressure loggers have a small diameter (20 to 30 mm) and are thus well suited for measurements in small-diameter pipes.

The water levels of open water surfaces are usually read from a staff gauge (Figure 27) or a water-level indicator installed at the edge of the water surface. A pressure logger is most convenient for this purpose, because no special structures are required; the cylinder only needs to be anchored in the river bed.

The water table reacts to the various recharge and discharge components that form a groundwater system, and is therefore constantly changing. Important in any drainage investigation are the (mean) highest and the (mean) lowest water table positions, as well as the mean water table depth in a hydrological year. For this reason, water-level measurements have to be taken at frequent intervals for at least a year. The interval between readings should not exceed one month, but a fortnight may be better. All measurements in the project area should, as far as possible, be made over the shortest time span possible so that a complete picture of the water table in that time span can be obtained.

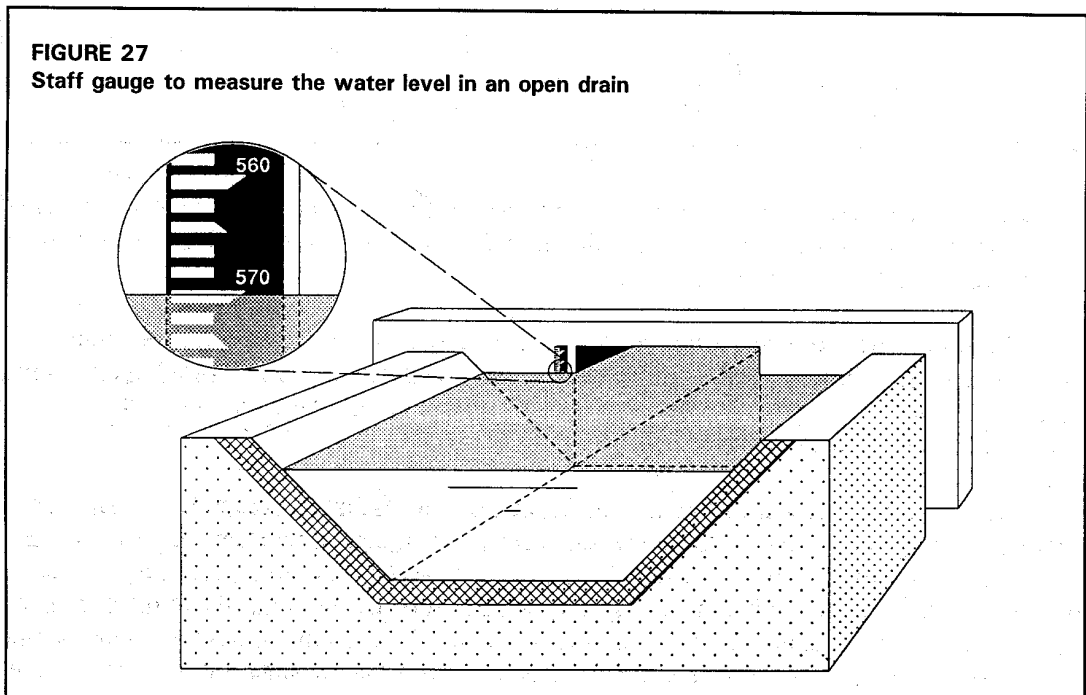
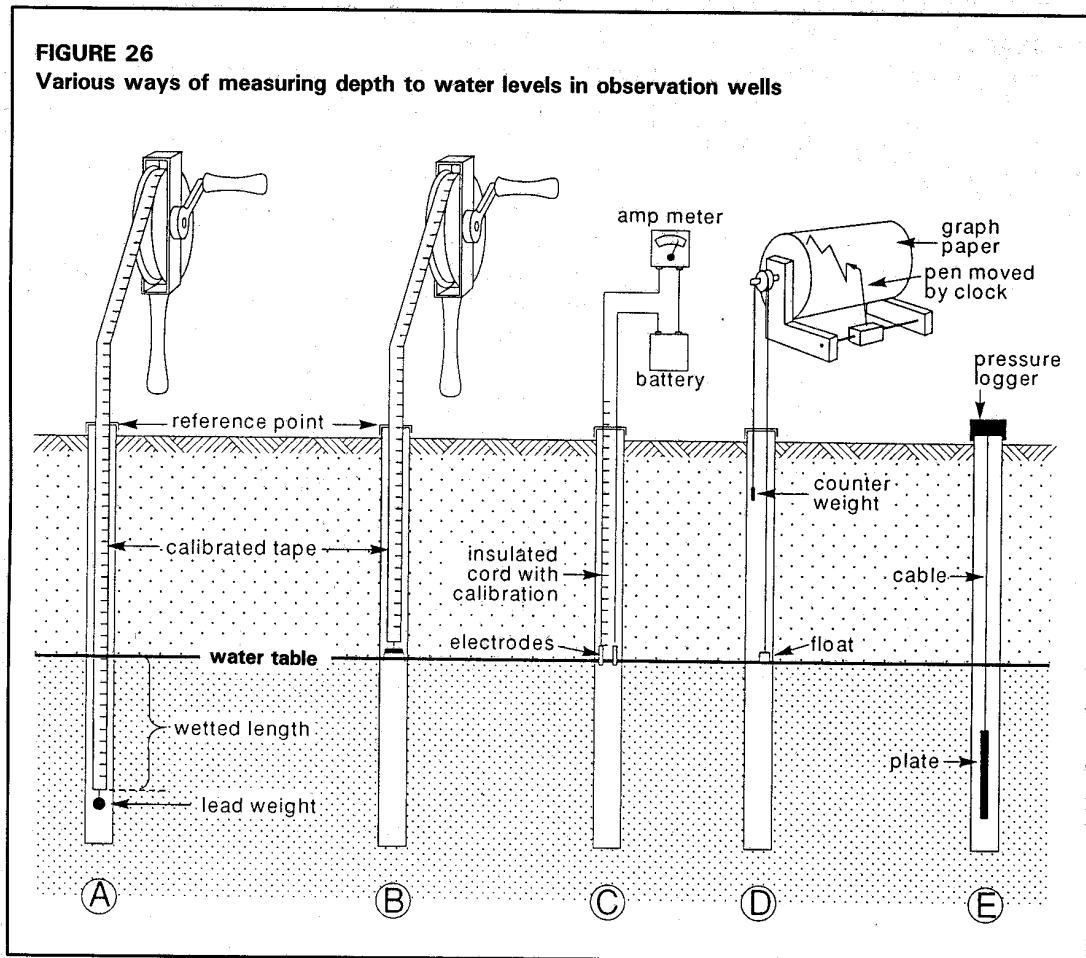

Each time a water-level measurement is made, the data should be recorded in a notebook. Pre-printed forms are very handy for this purpose. An example is shown in Figure 28. Even better is to enter the data in a computerized database system. Recorded for each observation are: date of observation, observed depth of the water level below the reference point, calculated depth below ground surface, and calculated water-level elevation (with respect to a general datum plane, e.g. mean sea level). Other particulars should also be noted (e.g. the number of the well, its location, depth, surface elevation, reference point elevation).

If a study of the effect that a rainstorm or an irrigation application has on the water table is needed, daily or even continuous readings may be required. To do this, a pressure logger or an automatic recorder is installed in a representative large-diameter well.

DISSOLVED SALTS IN THE GROUNDWATER

All groundwater contains salts in solution. The type of salts depends on the geological environment, the source of the groundwater, and its movement. Irrigation is also a source of the salts in the groundwater. It not only adds salts to the soil, but also dissolves salts in the root zone. Water that has passed through the root zone of irrigated land usually contains salt concentrations several times higher than that of the originally applied irrigation water. Evapotranspiration tends to concentrate the salts at the surface of the land (Figure 29), but when they are dissolved, they increase the salinity of the groundwater. Therefore highly saline groundwater is often found in arid regions with poor natural drainage.

MEASURING GROUNDWATER SALINITY

The choice of a method to measure groundwater salinity depends on the reason for making the measurements, the size of the area (and hence the number of samples to be taken and measured), and the time and the budget available for doing the work.

Once the network of observation wells and boreholes has been set out, a representative number of water samples is taken. Sampling can often best be combined with other drainage investigations, such as measuring hydraulic conductivity in open boreholes.

The salinity of groundwater can be rapidly determined by measuring its electrical conductivity (EC).

<p>Electrical conductivity (EC) is a measure of the concentration of salts, defined as the conductance of a cubic centimetre of water at a standard temperature of 25° C.</p>
--

FIGURE 28

Example of a pre-printed form for recording water table levels

GENERAL DATA

MAP NO..... COORDINATES: X=..... Y=.....

MUNICIPALITY PROVINCE.....

OWNER..... INSTALLATION DATE..... TYPE¹.....

DEPTH..... SCREENED PART..... AQUIFER TYPE².....

WELL LOG: FILE NO..... WATER SAMPLES: FILE NO.....

SURFACE ELEVATION..... REFERENCE POINT ELEVATION.....

OBSERVATION POINT NO.....

OBSERVATIONS

DATE	READING ³	ELEVATION ⁴	DEPTH ⁵	REMARKS ⁶

1 e.g. village well, open bore hole, piezometer

2 e.g. unconfined aquifer, semi-confined aquifer, semi-pervious covering layer

3 with respect to reference point

4 with respect to general datum. for example mean sea level

5 below ground surface (for phreatic levels only)

6 data on water sample, irrigation, water at the surface, flow from wells, water withdrawal (pumping), etc.

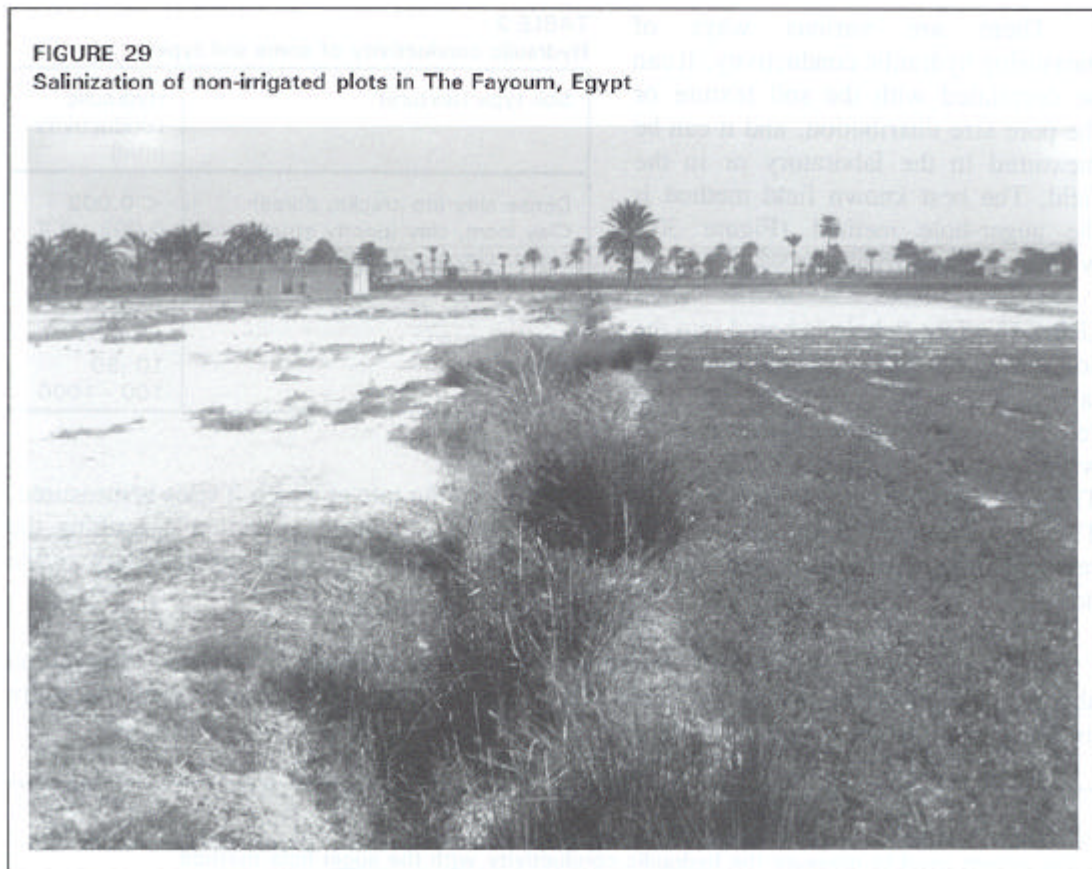

Electrical conductivity is expressed in deciSiemens per metre (dS/m), formerly in millimhos per centimetre (mmhos/cm). Expressing the results in terms of specific electrical conductivity makes the determination independent of the size of the water sample. Conductivity cannot simply be related to the total dissolved solids because groundwater contains a variety of ionic and undissociated species. An approximate relationship for most groundwater with an EC-value in the range of 0.1 to 5 dS/m is: 1 dS/m \approx 640 mg/l.

The EC expresses the total concentration of soluble salts in the groundwater, but gives no information on the types of salts. These may be calcium, magnesium, sodium, potassium, carbonate, bicarbonate, chloride, sulphate, and nitrate, and need to be determined in the laboratory. Since these chemical analyses are costly, not all the observation points need be sampled for detailed analysis. A selection of sites should be made, based on the results of the EC-measurements.

HYDRAULIC CONDUCTIVITY

The hydraulic conductivity (also known as the K-value) is a measure of the water-transmitting capacity of soils. There are big differences between the K-values of soil types, mainly depending on their texture (Table 2).

Hydraulic conductivity is a measure of the water-transmitting capacity of a soil.

There are various ways of measuring hydraulic conductivity. It can be correlated with the soil texture or the pore size distribution, and it can be measured in the laboratory or in the field. The best known field method is the auger-hole method (Figure 30), which works as follows:

Using an auger, a hole is bored into the soil to a certain depth below the water table. When the water in the hole reaches equilibrium with the ground-water, some of the water is bailed out. The groundwater then begins to seep into the hole, and the rate at which it rises is measured. Then the hydraulic conductivity of the soil is calculated with an equation describing the relationship between the rate of rise, the groundwater conditions, and the geometry of the hole.

The auger-hole method measures the K-value around the hole. It gives no information about vertical K-values or about K-values in deeper soil layers. The method is therefore more useful in shallow aquifers than in deep ones.

TABLE 2
Hydraulic conductivity of some soil types

Soil type (texture)	Hydraulic conductivity (m/d)
Dense clay (no cracks, pores)	< 0.002
Clay loam, clay (poorly structured)	0.002 - 0.2
Loam, clay loam, clay (well-structured)	0.5 - 2.0
Sandy loam, fine sand	1 - 3
Medium sand	1 - 5
Coarse sand	10 -50
Gravel	100 - 1000

FIGURE 30

Equipment used to measure the hydraulic conductivity with the auger-hole method



TOPOGRAPHY

Information on the topography of an area with a drainage problem is essential, because the excess water has to be removed by gravity flow. The topographic map should show all physical features – both natural and man-made – which will influence the design of the drainage system (Figure 31). Minor differences in the elevation of the land surface are important. How to conduct topographic surveys at farm level was discussed in Training Manual No. 2 *Topographic Surveying*.

FIGURE 31
Topographic map of an irrigated area

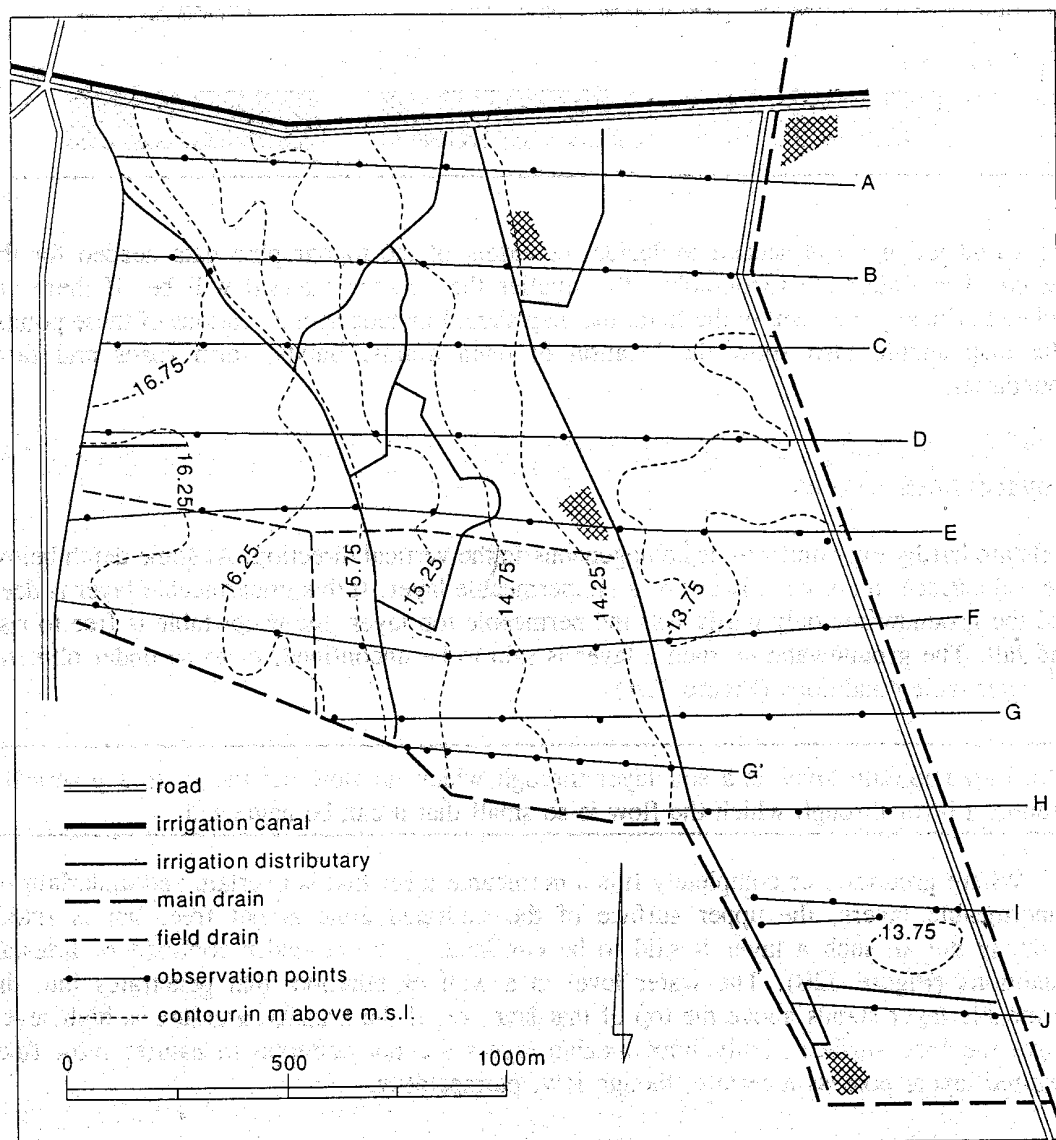

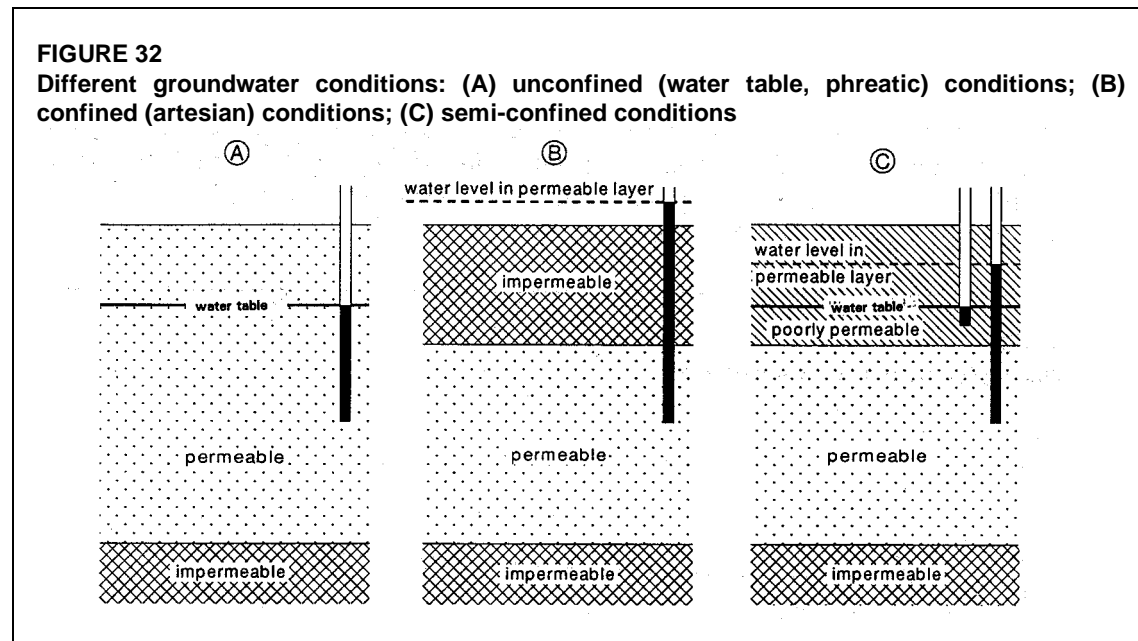

Good judgment is needed to decide the extent of the topographic data needed for the design. The flatter the topography, the smaller the contour interval will be. If there are isolated critical points within the field, the map should include spot elevations of these points. The map should also show the location of open drains, bunds, farm roads and farm boundaries.

IMPERMEABLE LAYERS

Soils are hardly ever uniform or homogeneous in the vertical direction. At some depth below the soil surface, there will always be an impermeable layer. If this impermeable layer is deep and the groundwater only partly fills the permeable top layer, the water table is free to rise and fall. The groundwater in such a layer is said to be unconfined, or to be under phreatic or water table conditions (Figure 32A).

An **impermeable layer** is a soil layer through which no flow occurs or, in a practical sense, a layer through which the flow is so small that it can be neglected.

Where groundwater completely fills a permeable layer that is overlain and underlain by impermeable layers, the upper surface of the saturated zone is not free, but is fixed. Groundwater in such a layer is said to be confined, or to be under confined or artesian conditions (Figure 32B). The water level in a well or borehole that penetrates into the permeable layer stands above the top of that layer or, if the artesian pressure is high, even above the land surface. Truly impermeable layers are not common in nature; most fine-textured layers possess a certain, though low, permeability.

Where groundwater completely fills a permeable layer that is overlain by a poorly permeable layer and underlain by an impermeable layer, the groundwater in the permeable layer is said to be semi-confined (Figure 32C). In the overlying, poorly permeable layer, the groundwater is under unconfined conditions because it is free to rise and fall.

Chapter 5

Design considerations

DRAINAGE AS PART OF AN AGRICULTURAL DEVELOPMENT PROJECT

Land drainage usually forms part of an agricultural development project. In such a project, land drainage is just one of the activities. The design of a drainage system is always a multidisciplinary effort, involving agronomists, extension specialists, agricultural, irrigation and drainage engineers and, of course, the beneficiaries (Figure 33). In this manual, emphasis is on drainage systems at field level, so some of the major aspects of their design and construction will be discussed.

LAYOUT OF FIELD DRAINAGE SYSTEMS

The length of the field drains is determined either by fixed (farm) boundaries or by a fixed length for the drain. It is often decided to place the field drains at right angles to the collectors (Figure 34). If so, it may happen that the field drains do not run parallel to the minor infrastructure (e.g. irrigation canals or farm roads). In such a case, it is better to install the field drains at such an angle to the collector that the number of crossings with the minor infrastructure is minimized.

The spacing of the collectors is often determined by the length of the field drains. The collector alignments are further fixed by the field boundaries. The length of a collector is restricted either by a field boundary or by the available slope. The available slope is fixed by the shallowest permissible drain depth, the maximum water level in the main drain, and the slope of the land surface.

The field drainage system is generally designed on a model basis for a sample area. This can be a single farm of less than one hectare or an area of more than hundreds of hectares. In such a sample area, the design variables (i.e. the soil and hydrological conditions and agricultural inputs) are considered to be uniform. This means that the design is only a guideline, which can be adjusted for each single farm to incorporate specific circumstances

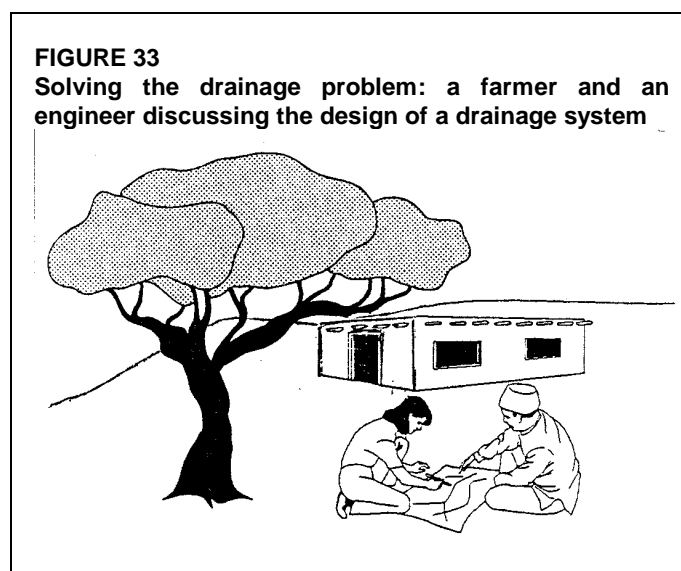

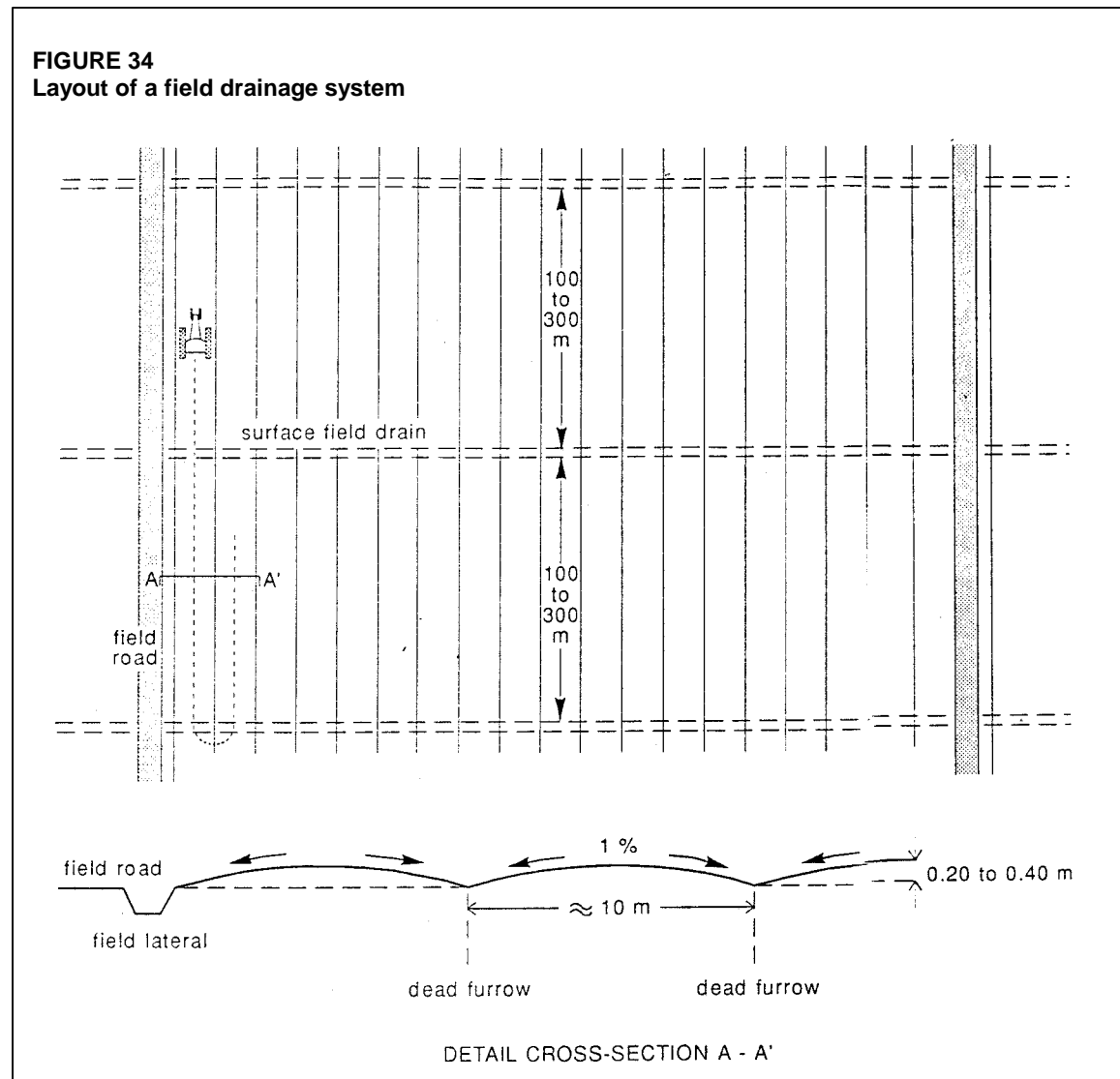

(e.g. a slightly heavier soil or a different cropping pattern, or a specific layout for the irrigation canals).

SURFACE AND SUBSURFACE DRAINAGE SYSTEMS

Depending on the kind of drainage problem faced, a choice has to be taken on the type of drainage system that will help to overcome the problem (Figure 35). This may be a surface drainage system, a subsurface drainage system, or a combination of the two.

In some areas, drainage problems can be caused by a perched water table. The true water table may be relatively deep, but a hard pan or other impeding layer in the soil profile creates a local water table above that layer or hardpan. If the impeding layer is at shallow depth (0.2 - 0.4 m), the drainage problem can probably be solved by deep ploughing or scarifying.

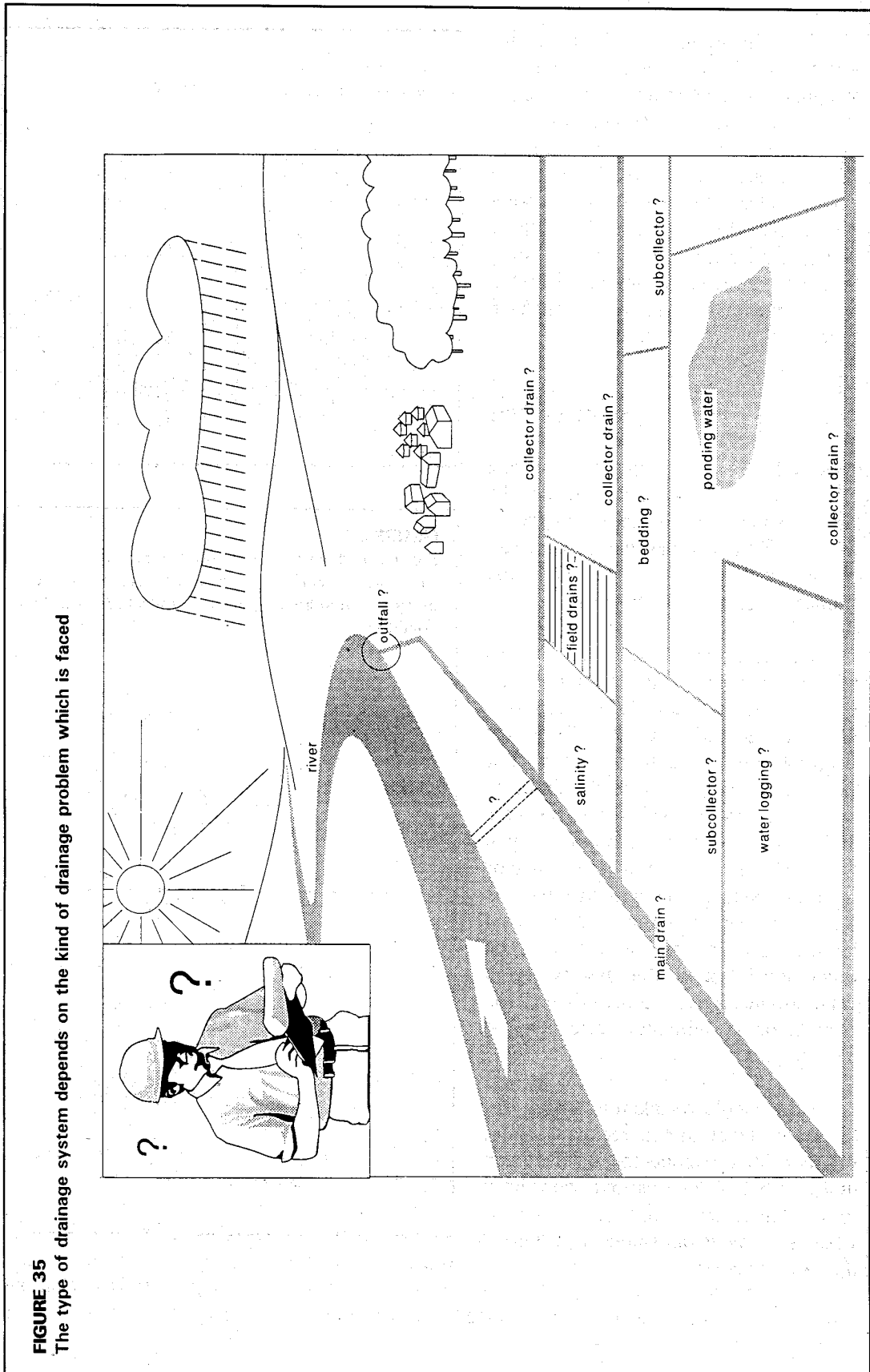

FIGURE 35
The type of drainage system depends on the kind of drainage problem which is faced

If the impeding layer is at greater depth (0.4 - 0.8 m), mole drainage can be applied. Mole drainage is a special type of subsurface drainage that uses unlined underground drainage channels. These channels are formed by pulling a solid cylinder with a wedge-shaped point at one end through the soil, without having to dig a trench (Figure 36). Mole drainage can reduce saturation of the top soil by enhancing shallow subsurface drainage flow to field drains.

OUTLET OF A FIELD DRAINAGE SYSTEM

Irrespective of the type of drainage system that will be installed on the farm, a good outlet is a prerequisite for success. If there is no way to evacuate the water away from the field, the drainage system will not work.

The water level at the outlet defines the drainage base. It determines the hydraulic head available for drainage flow. The drainage base is different for different points in a drainage area. For the field drainage system, the drainage base is the water level in the collector drains, whether they be pipes or open drains (Figure 37). For the collector drainage system, the drainage base is the water level in the main drain. And for the main drainage system, it is the water level below the gravity outlet structure during critical periods for crop growth, or the minimum water level at the pumping station.

Care should be taken to ensure that the water level in the recipient drain, whether it is a collector or the main drain, is below the required water level in the field, especially in the period when drainage is most important (e.g. in the rainy season).

FIGURE 36
Mole plough attached to a tractor

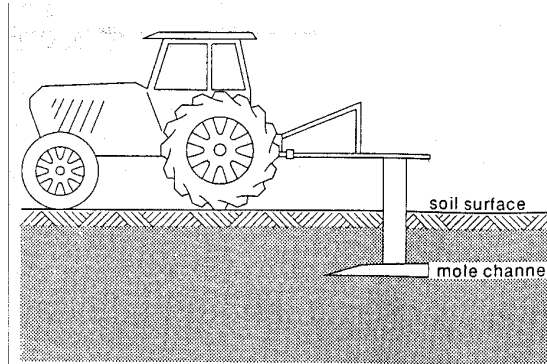
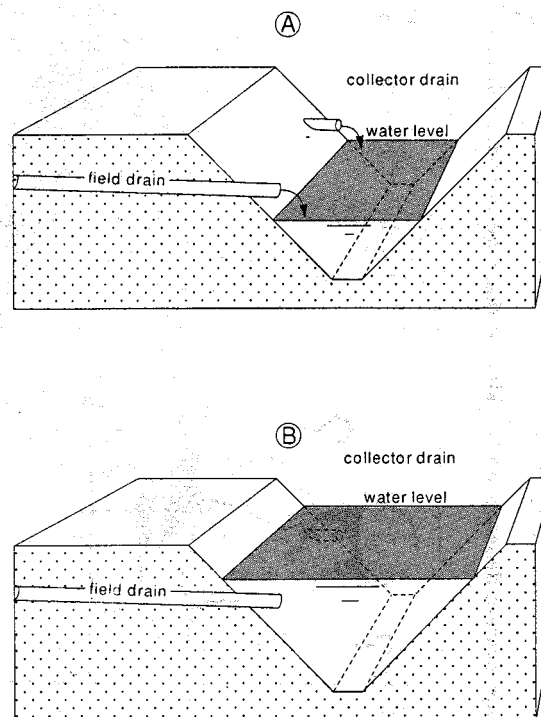

FIGURE 37
For the field drainage system, the drainage base is the water level in the collector drain: (A) free outflow conditions; (B) restricted outflow conditions



DESIGN DISCHARGE

The dimensions of drains, whether they be open drains or pipe drains, are based on the required design discharge. This design discharge is influenced by the storage capacity of the drainage system. By reducing ponding or waterlogging, a drainage system creates a buffer capacity in the soil, ensuring that the discharge is steadier and smaller than the recharge.

If the soil has a large buffer capacity, a longer period of critical duration can be adopted and average recharge and discharge rates over this longer period can be used. In contrast, if the soil has only a small buffer capacity, the infrequent, extreme, recharge and discharge rates have to be assessed and shorter periods of critical duration have to be adopted.

Subsurface drainage systems create a medium storage capacity. In regions with low rainfall intensities (say less than 100 mm/month) and in irrigated lands in arid or semi-arid regions, the design discharge for the month or season with the highest net recharge has to be calculated.

In regions that have seasons with high rainfall (say more than 100 mm per month), it is likely that the problem is one of surface drainage rather than of subsurface drainage. Here, a subsurface system would not be appropriate, or it could be combined with a surface system. In a combined system, the design discharge of the subsurface system has to be calculated from a water balance after the discharge from the surface system has been deducted.

A surface field drainage system, consisting of beds in flat lands or mildly graded field slopes in undulating lands, creates only small capacities for storage. The design discharge must then be based on the water balance over a short period (say 2 to 5 days).

SLOPES OF FIELD DRAINS

The maximum slope of field drains is dictated by the maximum permissible flow velocity. If the topography should call for steep slopes, drop structures should be built into the drains. For pipe drains, these are normally incorporated in manholes.

Special caution is needed if a steep slope changes to a flatter slope: high pressures may develop at the transition point unless the flow velocity on the upstream side is properly controlled and the downstream (flatter) reach has a sufficient capacity.

Chapter 6

Surface drainage systems

As was discussed in Chapter 3, a surface drainage system always has two components: (1) land forming, which is bedding, land grading, or land planing, and (2) the construction of field and collector drains. The three types of land forming are discussed first, followed by the design and construction of open drains.

LAND FORMING

Bedding

Design considerations

To ensure good drainage in a bedding system, the beds should not be more than 10 m wide. Further, the width of the beds is governed by the following:

- The kind of crops to be grown: Field crops require narrower beds than permanent pasture or hay crops do.
- Farming operations on beds: Ploughing, planting, and cultivating should fit the width of a bed. Bed width should be a multiple of the effective width of farm equipment.
- Soil characteristics: Soils with low infiltration and low hydraulic conductivity require narrower beds than soils with better characteristics.

Construction

Figure 38 shows how a bedding system is constructed. It often takes several years of ploughing to obtain an adequate bedding system. During the first ploughing, care should be taken to make beds of uniform width throughout the field and to have the field drains running in the direction of the greatest slope. Any obstructions or low points in the field drains should be eliminated because they will cause standing water and loss of crops. The collector drain should be laid out in the direction of the lesser field slope, and should be properly graded towards the main drainage system.

Land grading and land planing

When grading land for surface drainage, the slope does not need to be made uniform, as for irrigation; a non-uniform slope will suffice (Figure 39).

FIGURE 38
Construction of a bedding system

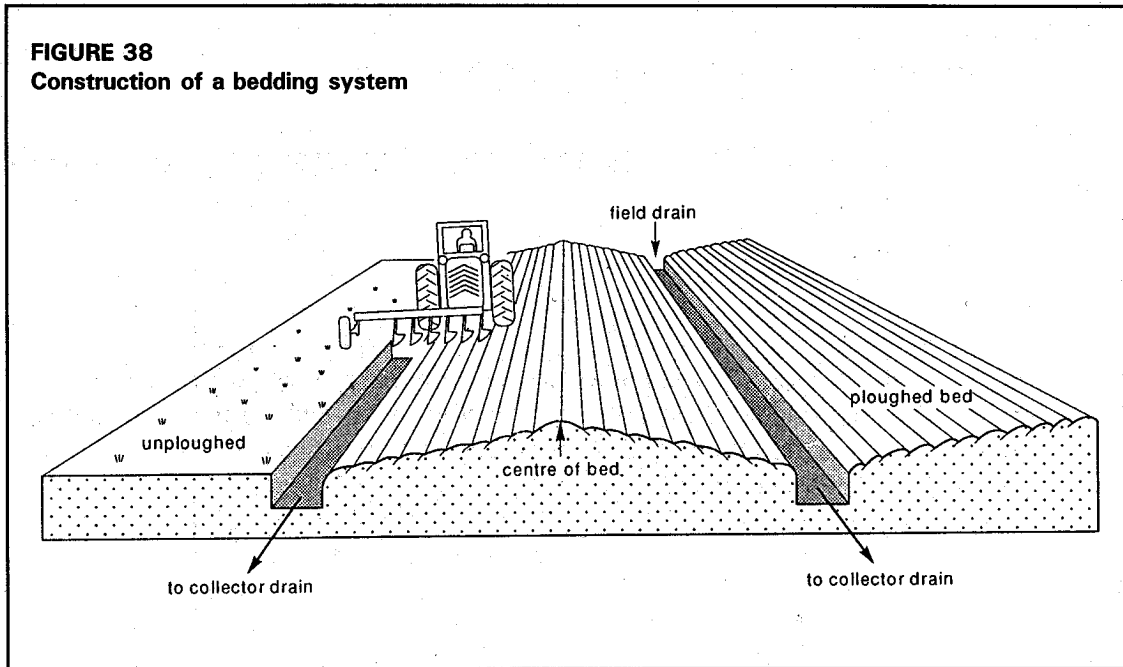
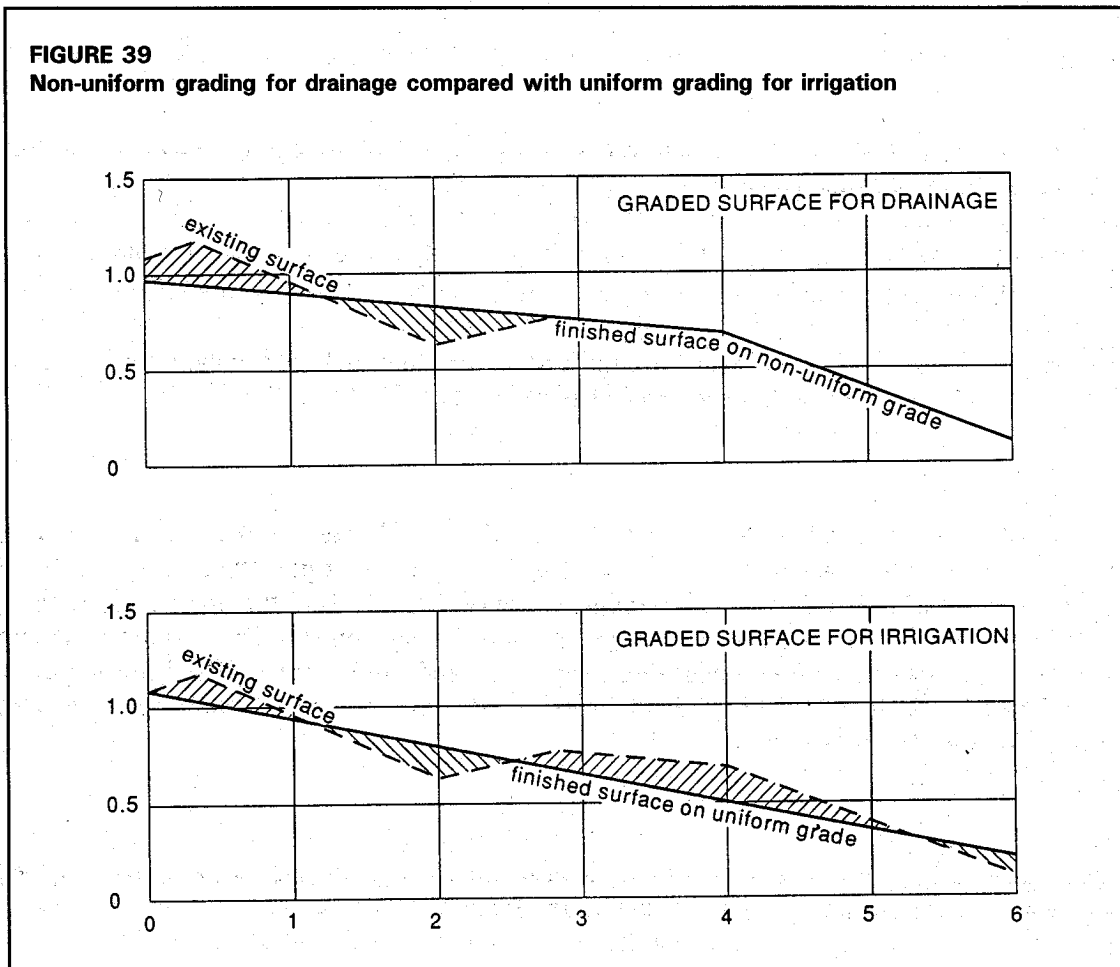
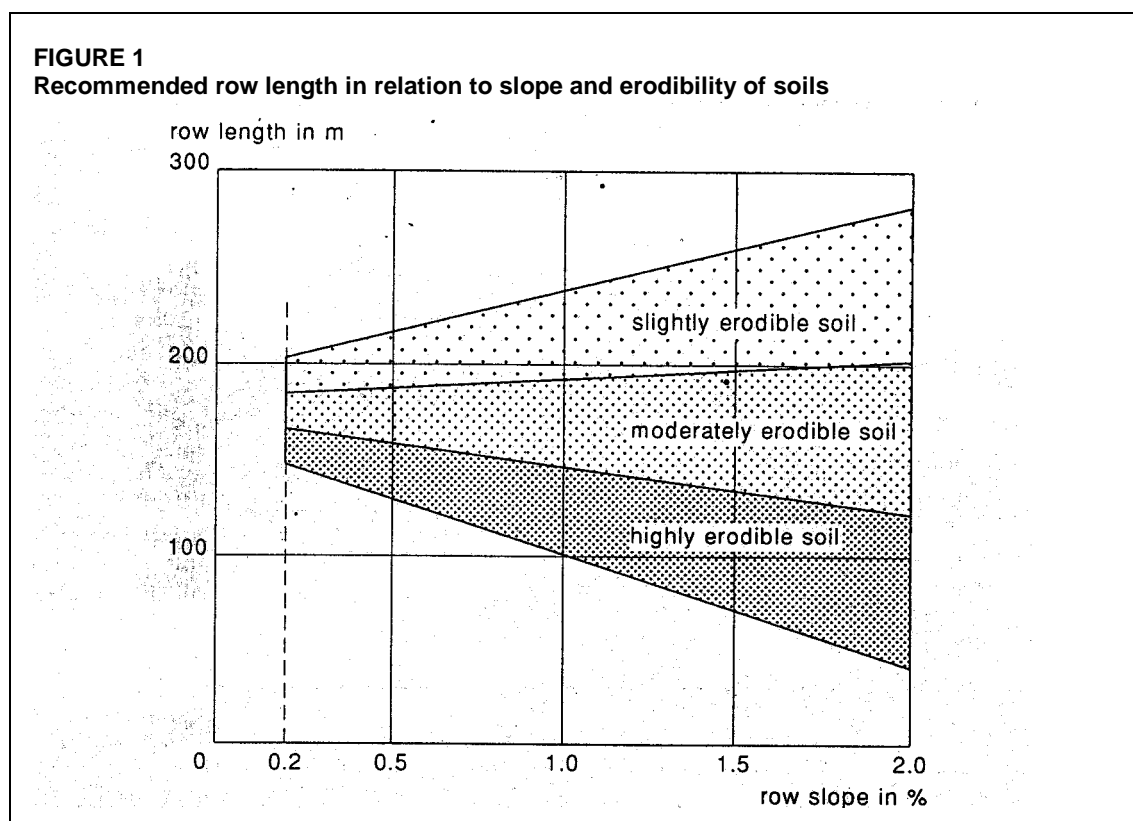

FIGURE 39
Non-uniform grading for drainage compared with uniform grading for irrigation





In addition, the types of crop and how they will be grown have to be considered. Crops like maize, potatoes, and sugar cane are grown in rows with small furrows in between. For such crops, the length of the rows and the slopes of the field must be selected so as to avoid erosion and overtopping of the small furrows. To prevent erosion, it is recommended that the flow velocities in the furrows should not exceed 0.5 m/s. In highly erodible soils, the row length is limited to about 150 m. Slightly erodible soils allow longer rows, up to 300 m. Figure 40 shows recommended lengths and slopes of rows (and the small field drains) in relation to soil erodibility. The direction of the rows and furrows need not necessarily be at right angles to the slope, but can be selected in any way that meets the above recommendations.

Small grains and hay crops are grown by broadcast sowing or in rows, but on an even surface (i.e. no furrows). For such crops, surface drainage takes place by sheet flow. This flow is always in the direction of the maximum slope. With sheet flow, the flow resistance is much higher than in small furrows, and the flow velocity on the same land slope is less. Even after careful land grading and smoothing, however, sheet flow always has a tendency to concentrate in shallow depressions, and gullies are easily formed (Figure 41). With the transport duration for low flow velocities in mind, it is recommended that the field length in the flow direction be limited to 200 m or less.

For wet-land rice and other crops grown in basins, the surface is levelled by earthmoving machinery (large basins) or with simple farm implements (Figure 42). Levelled fields are surrounded by field bunds. Any excess water from basins is usually drained through an overflow in the field bunds that spills the water directly into a field drain.

FIGURE 41
Sheet flow will easily result in erosion



FIGURE 42
Land levelling: final smoothing is done during the first irrigation

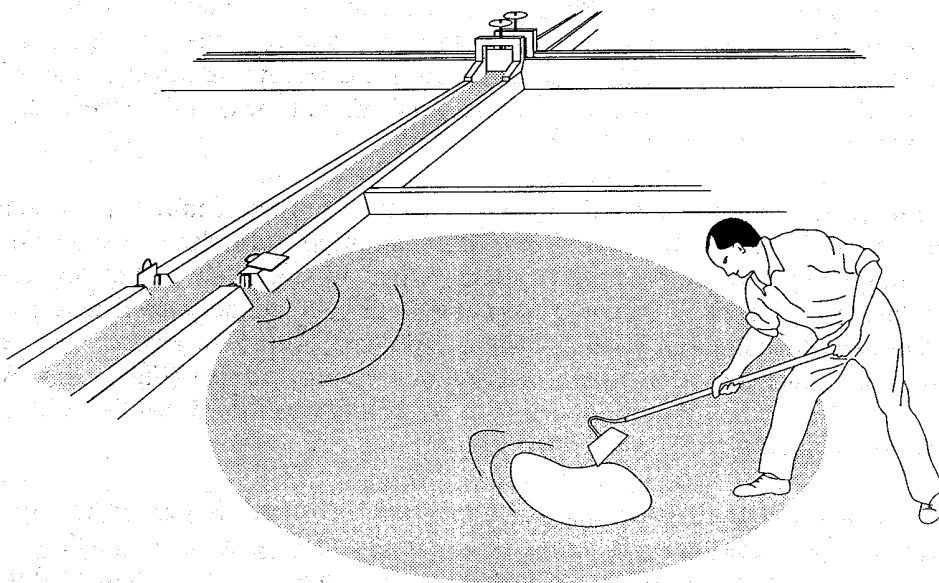

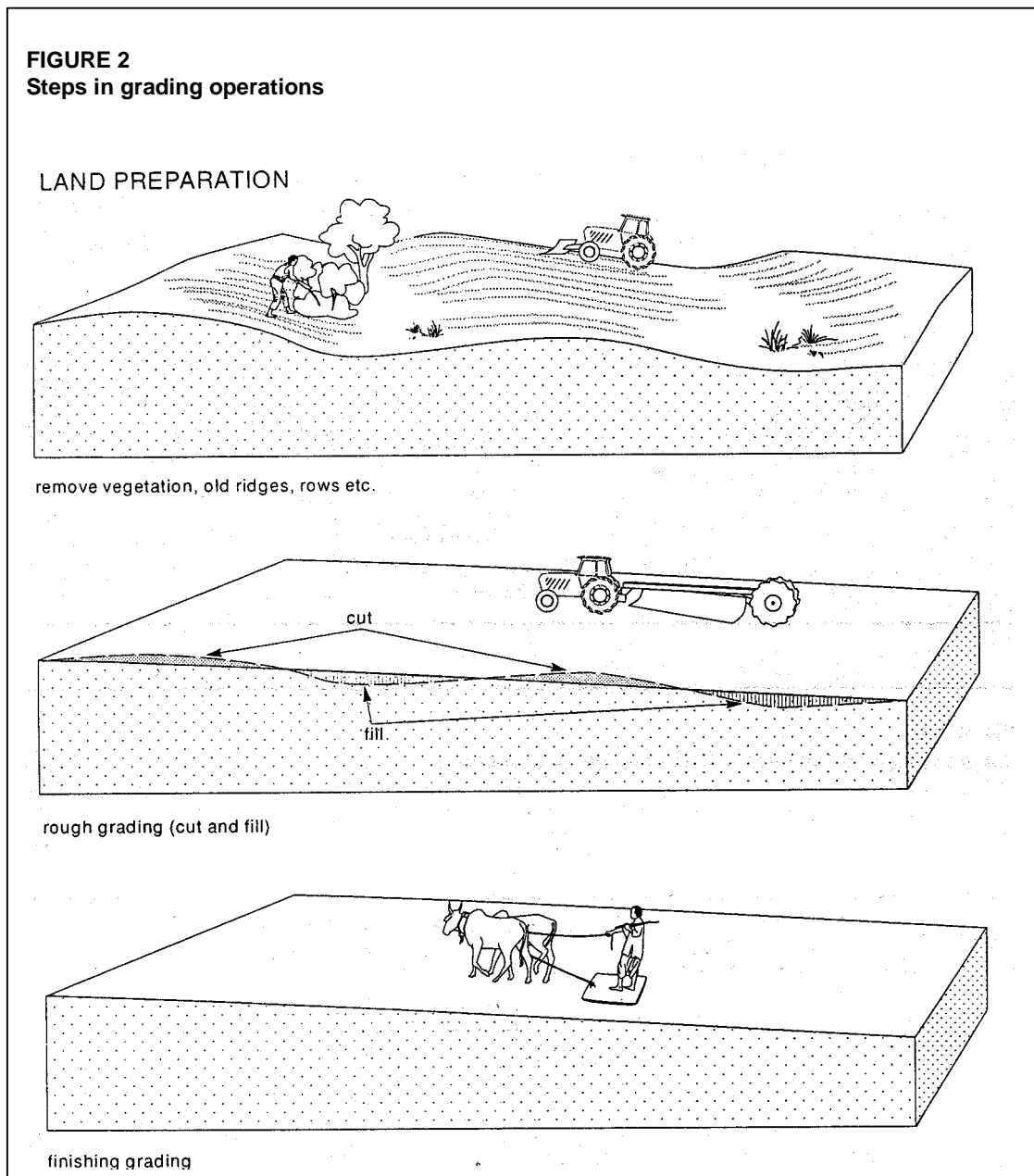

Construction

Land grading can be done by the farmers, although normal farm equipment, even if mechanized, can handle small-scale grading operations or the maintenance of already established grades. Large-scale land grading is done by contractors with conventional earthmoving equipment or with laser-guided motorized graders.

Grading operations involve a number of steps (Figure 43). The first step is to prepare the site. If the land has already been cleared, the work mainly involves removing or destroying vegetation and other obstacles, and levelling ridges or rows. This can normally be done with farm equipment. The surface should be dry, firm, and well-pulverized to enable the equipment to operate efficiently.

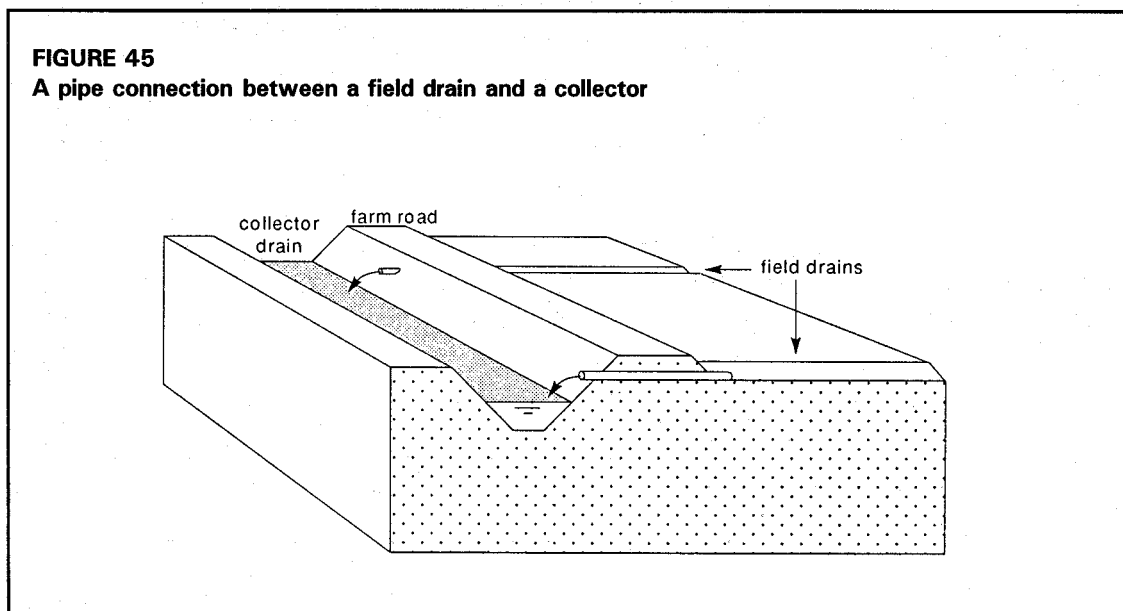
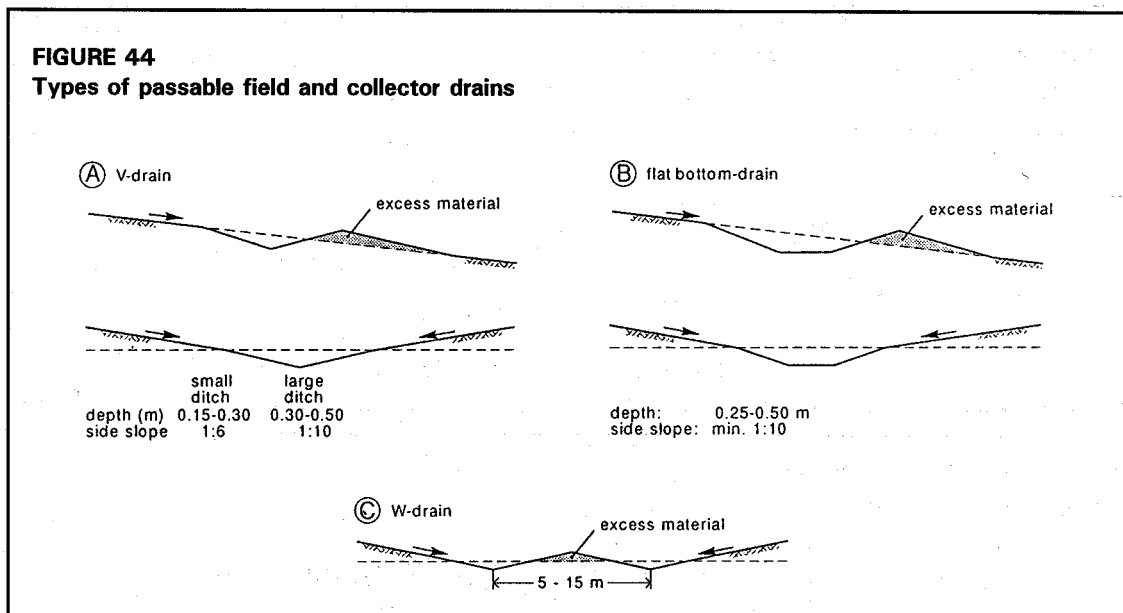

The second step is rough grading. This can be done with various types of equipment (e.g. dozers, motor graders, scrapers). The choice will depend on the soil conditions, the amount of earthwork needed, the time and equipment available, the size of the fields to be graded as one unit, and local experience.

The third step is the finished grading. On small fields, drags, harrows, and floats can be used. These implements can be pulled by a farm tractor or by animal traction. On larger fields, a land plane (a bottomless scraper) pulled by a farm tractor is used. For the final smoothing, several passes are usually made at angles to one another.

When extensive grading is done with heavy equipment, it is likely to cause the soil to become compacted. This compaction should be relieved to eliminate differences in soil productivity. Various tillage tools can be used for this work (e.g. subsoilers, chisels, scarifiers, and rippers).

FIELD DRAINS

Design of surface drains

Field drains for a surface drainage system have a different shape from field drains for subsurface drainage. Those for surface drainage have to allow farm equipment to cross them and should be easy to maintain with manual labour or ordinary mowers. Surface runoff reaches the field drains by flow through row furrows or by sheet flow. In the transition zone between drain and field, flow velocities should not induce erosion.

Field drains are thus shallow and have flat side slopes. Simple field drains are V-shaped. Their dimensions are determined by the construction equipment, maintenance needs, and their "crossability" by farm equipment. Side slopes should not be steeper than 6 to 1. Nevertheless, long field drains under conditions of high rainfall intensities, especially where field runoff from both sides accumulates in the drain, may require a transport capacity greater than that of a simple V-shaped channel. Without increasing the drain depth too much, its capacity can be enlarged by constructing a flat bottom, thereby creating a shallow trapezoidal shape. Figures 44A and B give some recommended dimensions of V-shaped and trapezoidal drains.

A variation is the W-shaped field drain, which is applicable where a farm road has to run between the drains (Figure 44C). These drains are generally farmed through and their upper slopes may well be planted. All field drains should be graded towards the collector drain with grades between 0.1 and 0.3%.

Open collector drains collect water from field drains and transport it to the main drainage system. In contrast to the field drain, the cross-section of collector drains should be designed to meet the required discharge capacity. The hydraulic design is similar to the design of irrigation canals. (See Training Manual No. 7 *Canals*.)

Besides the discharge capacity, the design should take into consideration that, in some cases, surface runoff from adjacent fields also flows directly into the field drains, which then require a gentler side slope.

When designing the system, maintenance requirements must be considered. For example, if the collector drains are to be maintained by mowing, side slopes should not be steeper than 3 to 1.

Attention must also be given to the transition between the field drains and the collector drains, because differences in depth might cause erosion at those places. For low discharges, pipes are a suitable means of protecting the transition (Figure 45). For higher discharges, open drop structures are recommended.

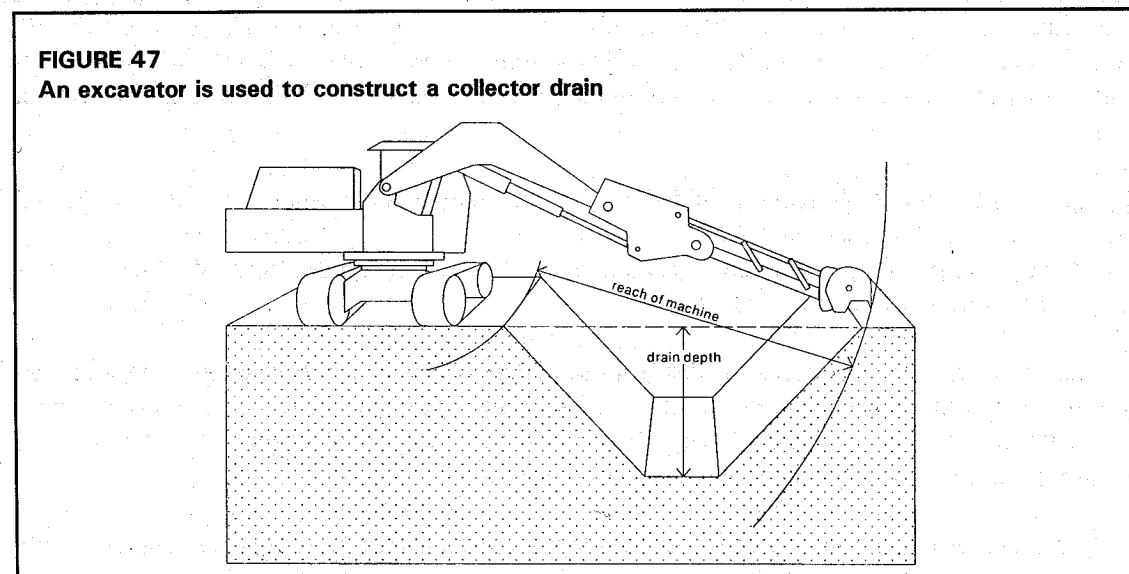
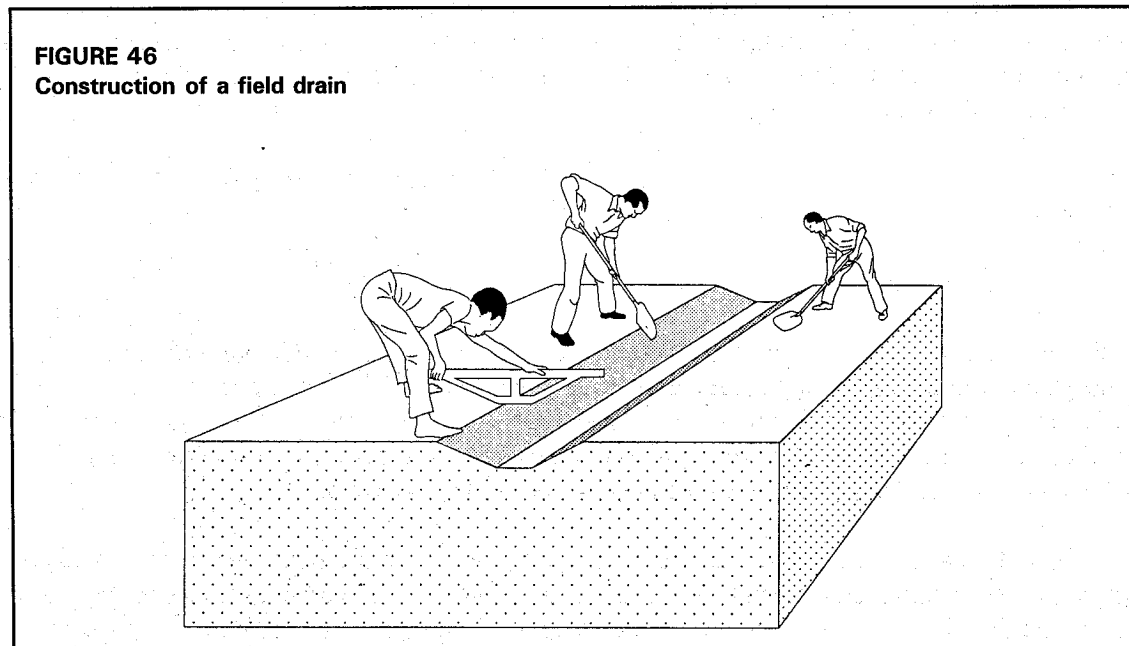

Construction of surface drains

Open surface drains can be constructed manually or mechanically (Figure 46). Care should be taken that the spoil from the drains does not block the inflow of runoff, but is deposited on the correct side of the ditch or is spread evenly over the adjacent fields.

Collector drains are usually constructed with different machinery than that used for field drains (i.e. excavators instead of land planes) (Figure 47). The soil is placed near the sides of the drain. Scrapers are needed when the excavated soil is to be transported some distance away.

Chapter 7

Subsurface drainage systems

TYPES OF SUBSURFACE DRAINAGE SYSTEMS

Subsurface drainage aims at controlling the water table – a control that may be achieved by tubewell drainage, open drains or subsurface drains (pipe drains or mole drains). Tubewell drainage and mole drainage are applied only in very specific conditions. Moreover, mole drainage is mainly aimed at a rapid removal of excess surface water, indirectly controlling the rise of the water table.

Open and pipe drains: The usual choice for subsurface drainage is therefore between open drains and pipe drains. This choice has to be made at two levels: for field drains and for collectors.

Open drains have the advantage that they can receive overland flow directly, but the disadvantages often outweigh the advantages. The main disadvantages are the loss of land, interference with the irrigation system, the splitting-up of the land into small parcels, which hampers mechanized farming operations, and a maintenance burden.

Tubewell drainage refers to the technique of controlling the water table and salinity in agricultural areas. It consists of pumping, from a series of wells, an amount of groundwater equal to the drainage requirement. The success of tubewell drainage depends on many factors, including the hydrological conditions of the area, the physical properties of the aquifer to be pumped and those of the overlying fine-textured layers.

Mole drainage: Heavy soils of low hydraulic conductivity (less than 0.01 m/day) often require very closely spaced drainage systems for satisfactory water control. With conventional pipe drains, the cost of such systems is usually uneconomic and hence alternative techniques are required. Surface drainage is one possibility; the other is mole drainage.

Mole drains are unlined circular soil channels which function like pipe drains. Their major advantage is their low cost and hence they can be installed economically at very close spacings. Their disadvantage is their restricted life but, providing benefit/cost ratios are favourable, a short life may be acceptable.

The success of a mole drainage system is dependent upon satisfactory water entry into the mole channel and upon the mole channel itself remaining stable and open for an acceptable period. Currently mole drainage systems are most commonly used for surface water control in perched water table situations; this is localized water tables above an impermeable layer.

FIGURE 48
Input factors for the calculation of drain spacings

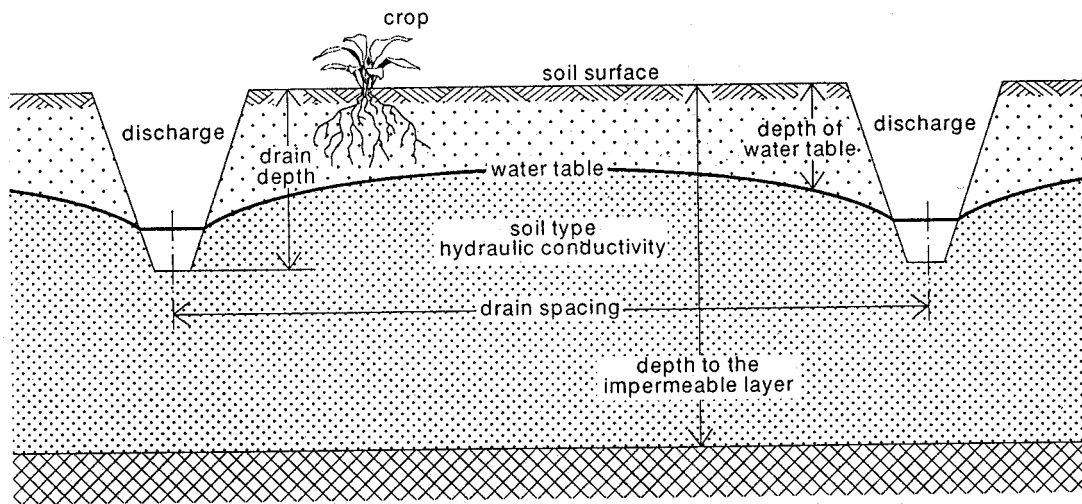
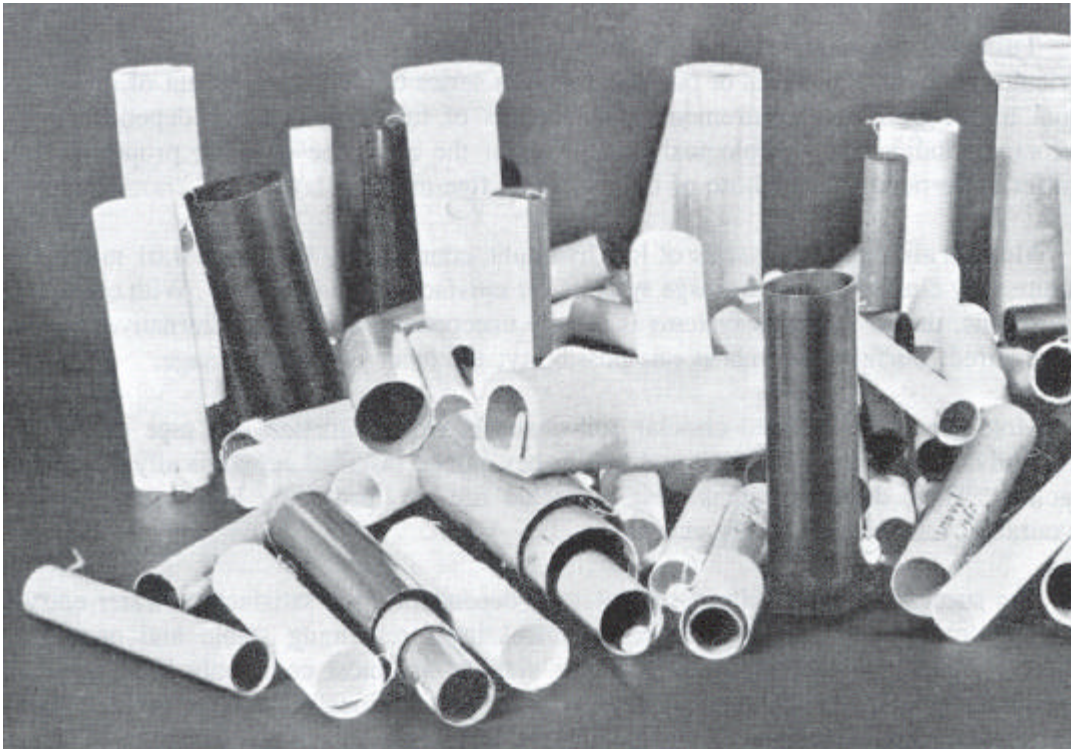

FIGURE 49
Different types of pipe drains



Mole drains are formed with a mole plough, which comprises a cylindrical foot attached to a narrow leg, followed by a slightly larger diameter cylindrical expander. The foot and expander form the drainage channel and the leg generates a slot with associated soil fissures which extends from the surface down into the channel. The mole plough is attached to the draw-bar of a tractor and the mole channel is installed at depths between 0.4 and 0.7 m. Common lengths of run vary from 20 to 100 m.

DESIGN OF SUBSURFACE DRAINAGE SYSTEMS

Depth and spacing of field drains

The depth and spacing of field drains are usually calculated with the help of drainage equations. The data needed for these calculations were discussed in Chapter 4 and include the agricultural requirements (depth of the water table and root depth), the soil characteristics (hydraulic conductivity and depth to the impermeable layer), and hydrological factors (drainage requirement) (Figure 48).

Calculated drain spacings normally show considerable variations due to the variations in input data. If so, the area should be divided into sub-areas or "blocks" of a convenient size (e.g. the area served by one collector). For each sub-area or block, a uniform and representative drain spacing can then be selected.

As an example, suppose that the calculated spacings in a project area vary between 18 and 85 m. Practical sets of standard spacings could then be: 20 - 25 - 30 - 40 - 50 - 60 - 80 m, or 20 - 30 - 45 - 60 - 80 m. It makes little sense to make the increments too small in view of the many inaccuracies and uncertainties in the entire process of calculating the spacings.

Pipes

The materials used in the manufacture of drain pipes are clay, concrete and (corrugated perforated) plastics (Figure 49). Important criteria for pipe quality and for selecting the most suitable type of pipe are the availability of raw materials, the resistance to mechanical and chemical damage, longevity and costs. The costs are the total costs for purchase, transport, handling and installation.

Envelopes

Sometimes, pipe drains are installed with an envelope. An envelope is the material placed around the pipe to perform one or more of the following functions:

- Filter function: to prevent or restrict soil particles from entering the pipe where they may settle and eventually clog the pipe.
- Hydraulic function: to constitute a medium of good permeability around the pipe and thus reduce entrance resistance.
- Bedding function: to provide all-round support to the pipe in order to prevent damage due to the soil load. Note that large-diameter plastic pipes are embedded in gravel especially for this purpose.

A wide variety of materials are used as envelopes for drain pipes, ranging from organic and mineral materials, to synthetic materials and mineral fibres. Organic material is mostly fibrous, and includes peat, coconut fibre and various organic waste products like straw, chaff, heather, and sawdust. Mineral materials are mostly used in a granular form; they may be gravel, slag of various kinds (industrial waste products), or fired clay granules. Synthetic materials may be in a granular form (e.g. polystyrene) or in a fibrous form (e.g. nylon, acryl and polypropylene). Glass fibre, glass wool and rock wool, which all are mineral fibres, are also used.

There are various ways of applying envelope materials. They can be applied in bulk, as thin sheets, or as more voluminous "mats". Bulk application is common for gravel, peat litter, various slags, and granules.

It is recommended to place the pipe in such a way that it is completely surrounded by the envelope material. In this way, the envelope material will fulfil its filter, hydraulic and bedding functions. Figure 50 shows a plastic pipe fully surrounded by gravel.

Thin sheets and mats are commonly used with corrugated perforated plastic pipe as a pre-wrapped envelope (Figure 51).

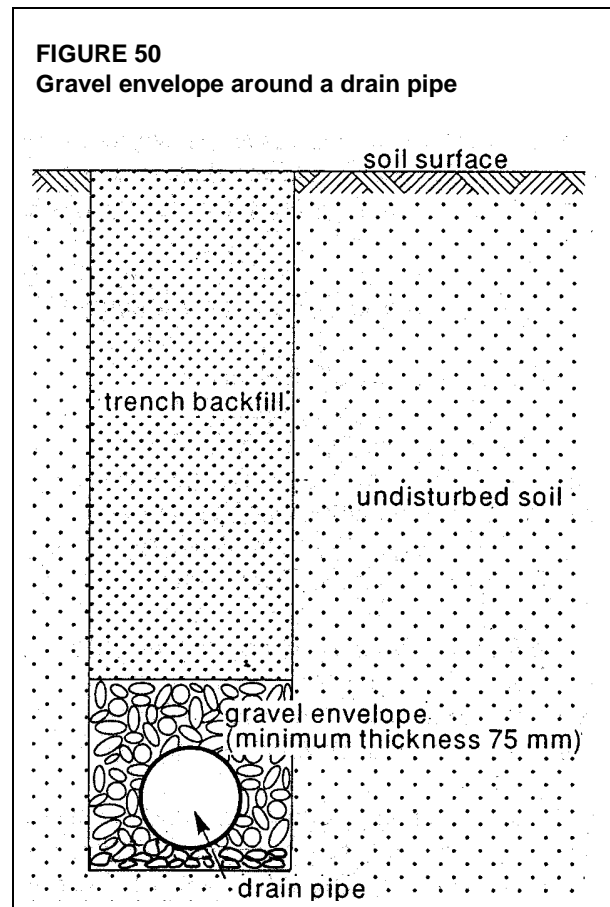

CONSTRUCTION OF PIPE DRAINAGE SYSTEMS

Construction methods

Pipe drainage systems are generally constructed by specialized contractors. They are selected after tenders have been called for, usually from a list of contractors drawn up by the authorities in a pre-qualification process. This type of construction work is beyond the scope of this manual. Only some matters directly related to the work at field level will be discussed.

The classical method of pipe installation consists of marking the alignments and levels, excavating the trenches by manual labour, placing the pipes and envelope material, and backfilling the trenches (Figure 52). Nowadays, field drains are installed by drainage machines, either trenchers or trenchless machines. Concrete collectors are often installed by excavators. In addition to the mechanics of installation, other important matters are the work planning, the working conditions, and supervision and inspection.

FIGURE 51
A pre-wrapped envelope

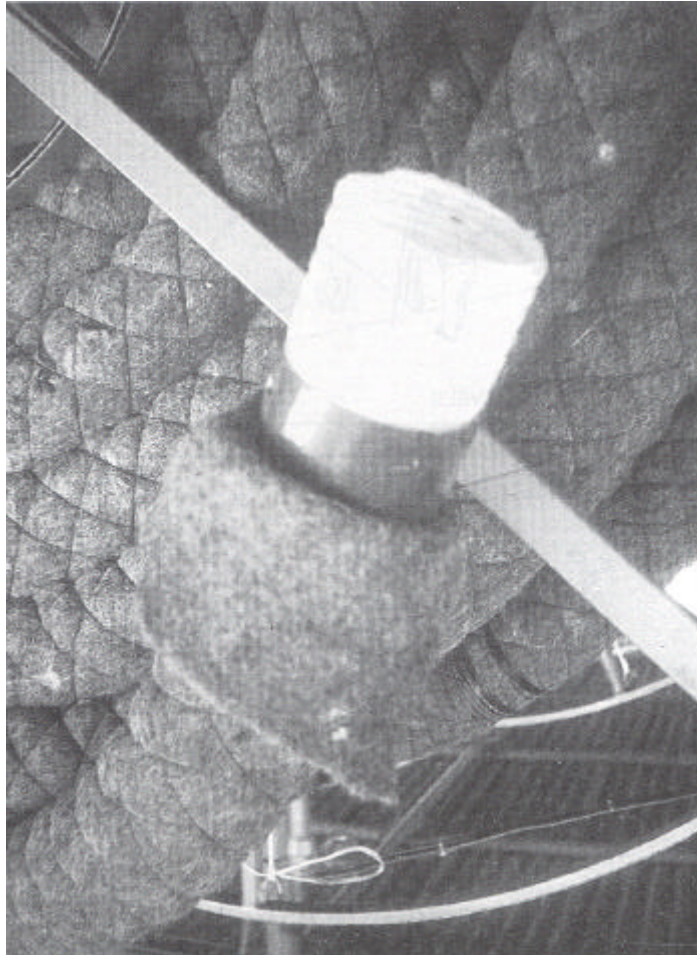

Alignment and levels

To mark alignments and levels, stakes are placed in the soil at both ends of a drain line, with the top of the stakes at a fixed height above the future trench bed. The slope of the drain line is thereby indicated. A row of boning rods is then placed in line (both vertically and horizontally) between the stakes, with an extension at the upstream end of the drain line, where the run of the drainage machine ends (Figure 53). The boning rods are thus in a line parallel to the trench bed. The driver of the drainage machine achieves grade control through sighting. The same principle can be applied when drains are installed manually.

Nowadays, most drainage machines have grade control by laser. An emitter, placed on a tripod near the edge of the field, establishes an adjustable reference plane over the field by means of a rotating laser beam (Figure 54). A receiver, mounted on the digging part of the drainage machine, picks up the signal. The control system of the machine continuously keeps a fixed mark in the laser plane. One position of the emitter can serve the installation of a fairly large number of drains.

FIGURE 52
Steps in the construction of a subsurface drainage system

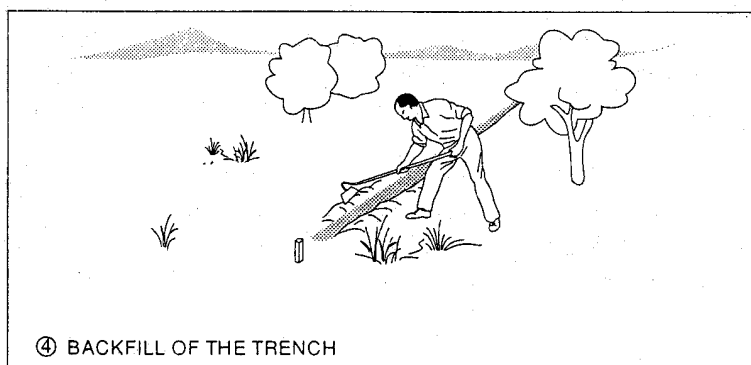
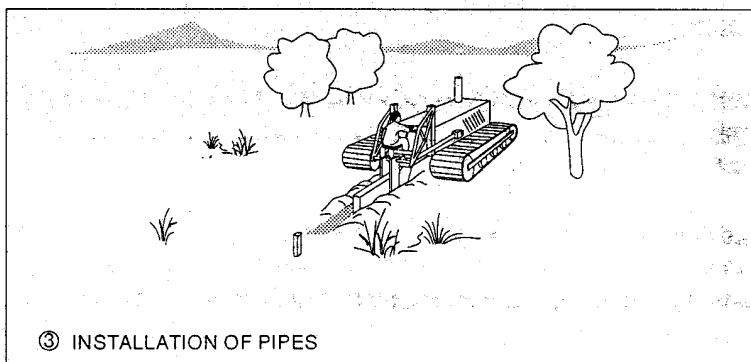
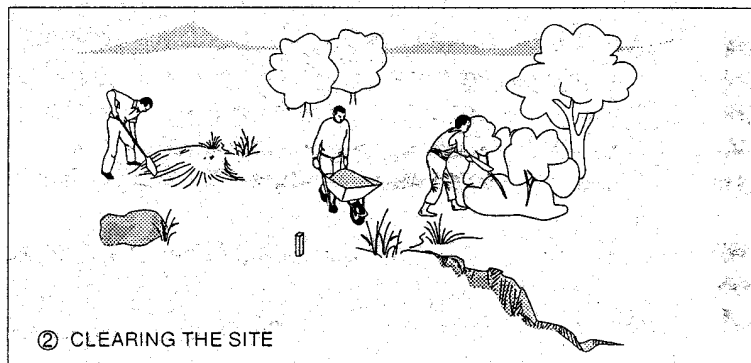
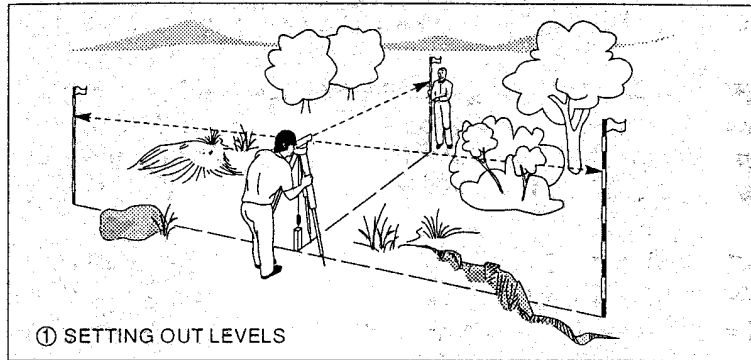

FIGURE 53
Setting out levels for drain pipe installation

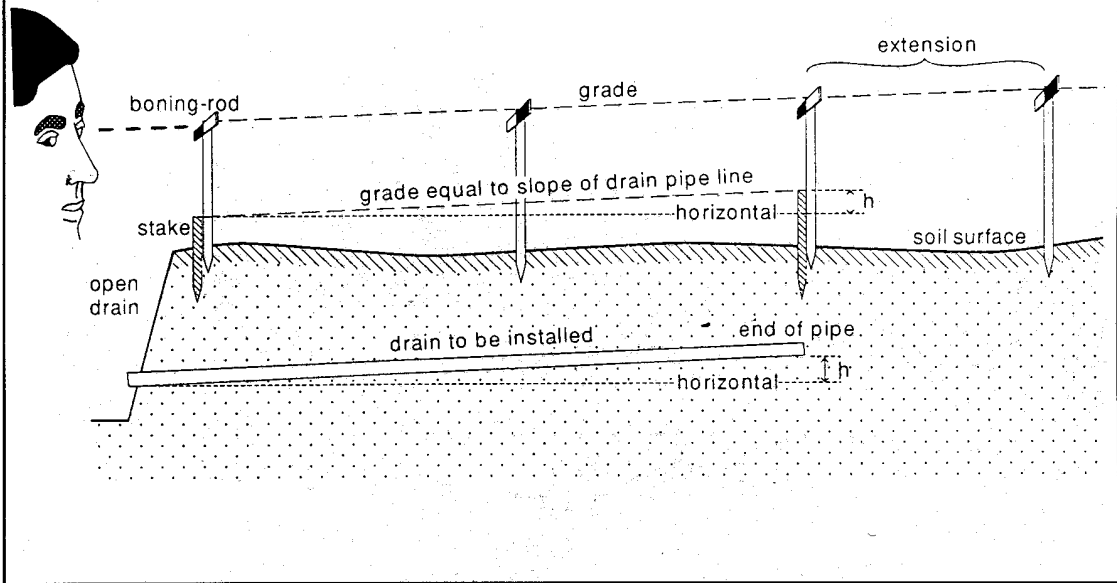

FIGURE 54
Grade control by laser for drain pipe installation

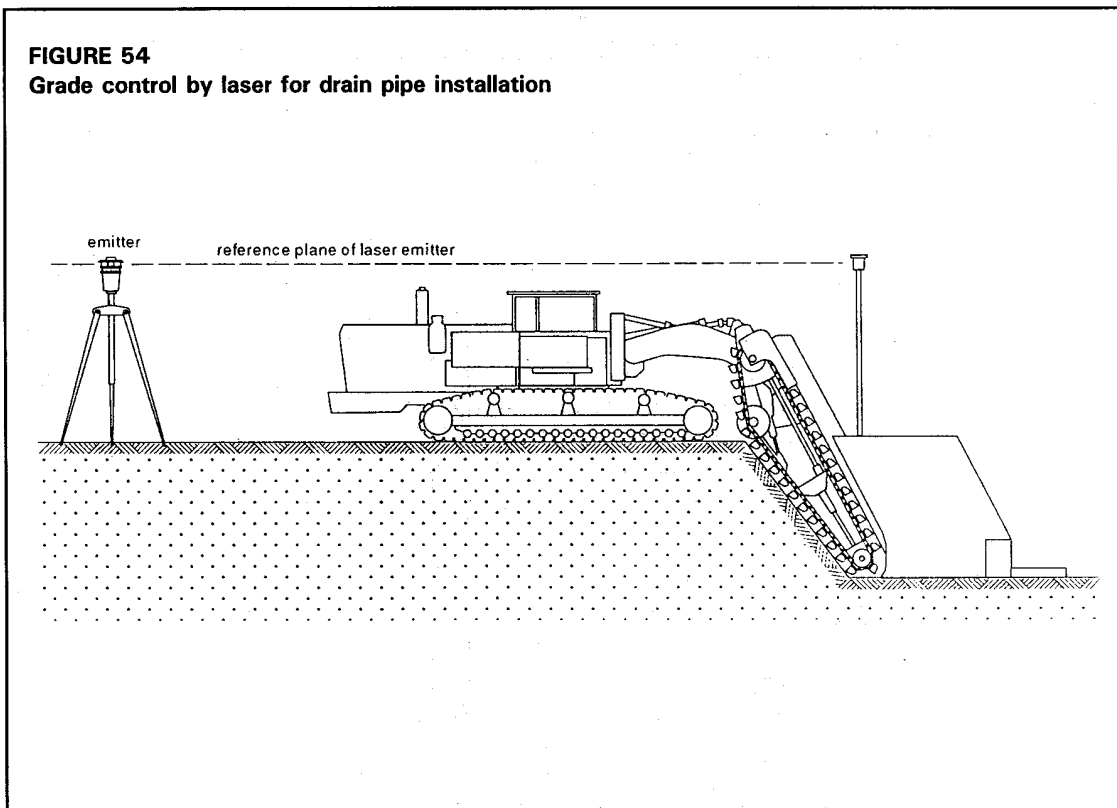
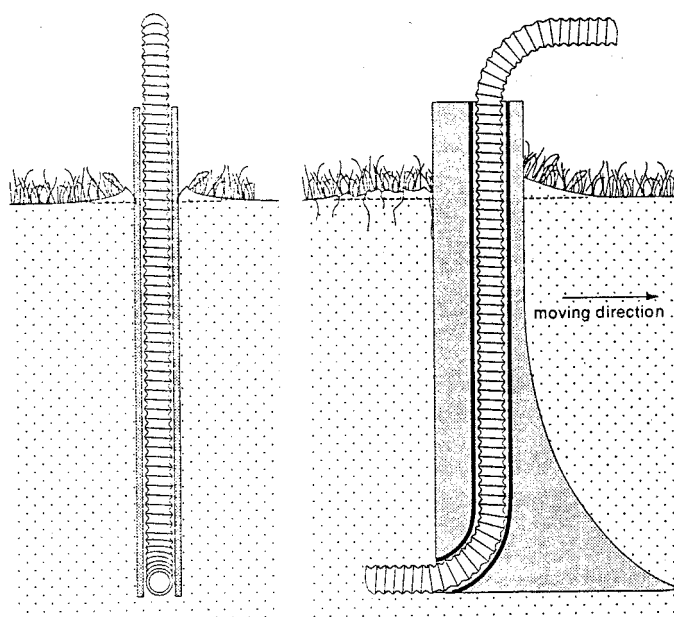
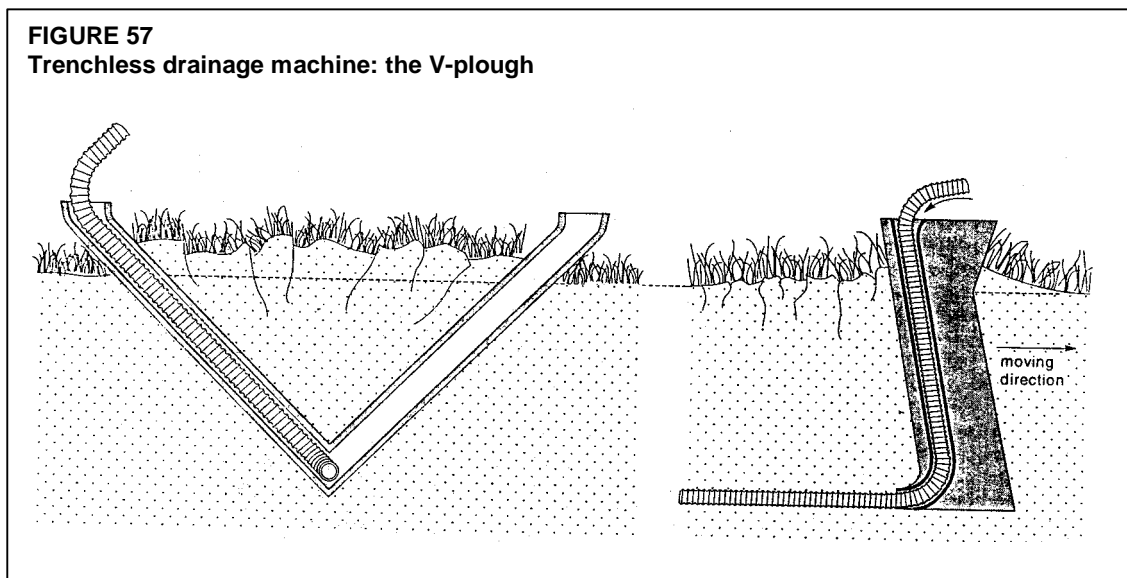

FIGURE 55
Trencher drainage machine



FIGURE 56
Trenchless drainage machine: the vertical plough





Machinery

The most common types of machines for installing field drains fall into two categories: trenchers and trenchless machines. Trenchers excavate a trench in which the pipe is laid, whereas trenchless machines merely lift the soil while the pipe is being installed.

Trenchers install the drains by excavating a trench and laying the pipe, including the envelope if applicable (Figure 55). The trench is backfilled afterwards by a tractor equipped with a dozer blade. Trenches should be backfilled the same day as they are dug to avoid a possible destabilization of soil under wet conditions (irrigation, rain, high water table). Running a tractor wheel over the backfilled trench, filling it up, and running over it again will take care of the required compaction. This procedure ensures that only the top part of the trench backfill is compacted, while the deeper part of the backfill retains a good permeability and a low entrance resistance.

The corrugated plastic pipe for small-diameter field drains is carried on the machine on a reel and is fed into the trench. Larger-diameter corrugated pipes (e.g. for collectors) are usually laid out and coupled in the field beforehand. The continuous tube is subsequently picked up and laid in the trench by the machine as it moves along. Clay tiles and concrete pipes move down a chute behind the digging chain.

Synthetic and organic envelopes are usually pre-wrapped around the corrugated pipe. For gravel envelopes, a hopper can be fitted into which the gravel is fed from a trailer moving alongside the drainage machine. For a complete gravel surround, two gravel hoppers can be fitted: one before the point where the pipe is fed in, and one after.

There are two types of trenchless drainage machines: the vertical plough (Figure 56) and the V-plough (Figure 57). The vertical plough acts as a subsoiler: the soil is lifted and large fissures and cracks are formed. The V-plough lifts a triangular "beam" of soil while the drain pipe is being installed. Backfilling is not needed, because no trench has been excavated. Nevertheless, when drains are installed with the vertical plough, the upper part of the



disturbed soil has to be compacted. A common procedure is that one track of the drainage machine runs over the drain line on its way back. In dry clay soil, this compaction may not be sufficient.

Corrugated plastic pipes are the only feasible pipes for trenchless machines. The V-plough can handle pipes with a maximum outside diameter, including the envelope, of 0.10 - 0.125 m. The vertical plough can handle much larger diameters. Although gravel envelopes would be possible with trenchless drainage, they are not recommended because of the risk of a clogged funnel and because of the difficulty of supplying gravel to a comparatively fast-moving machine. The only practical option is to use pre-wrapped envelopes.

The bottleneck for the speed of pipe installation is usually not the capacity of the drainage machine, but the organization and logistics connected with keeping the machine going. The preparation of the site (e.g. setting out, removing obstacles) is important, as is the operation and maintenance of the drainage machine (fuel supply, spare parts). In addition, the supply of

pipe and envelope material needs to be properly organized.

SUPERVISION AND INSPECTION

During the construction of the drainage system, the work should be regularly inspected and supervised (Figure 58). There are several reasons for this:

- to ensure that design specifications are complied with;
- to handle unforeseen conditions during installation;
- to check the quality of the structures and the materials used (pipes, envelope), which includes a site-check on possible damage during transport and handling;
- to ensure good workmanship, including the proper alignment of drain lines, which should be straight and according to the design slope, within an accepted tolerance (half the inside pipe diameter for field drains), and with proper joints;
- to see that the trenches are properly backfilled and compacted;
- to assess the need for any extra work or modifications, which implies that the supervisor should be a well-qualified person.

This inspection should cover both the total output (quantity control) and technical factors (quality control). Both types of inspection should be done regularly during execution because this enables any faults to be corrected immediately.

Chapter 8

Operation and maintenance

Once a drainage system has been installed, arrangements have to be made to ensure that it will function properly for a long time to come. For this, a good plan for its operation and maintenance is needed. In this plan, the following issues have to be addressed:

- Why and when is maintenance necessary? What are the objectives? What will be the frequency? What are the costs and benefits?
- Who is responsible for the planning, execution, control, and financing?
- How is it to be done and by whom: the government, the farmers, or contractors?
- How are the costs to be financed? Who will pay and how is the money to be collected?

This manual is restricted to the technical aspects of the operation and maintenance of drainage systems. The institutional aspects will be treated in Training Manual No. 10: *Irrigation Scheme Operation and Management*.

"AS-BUILT" DATA OF DRAINAGE WORKS

Maintaining a technically sound drainage system requires maintaining a good drainage base, making regular inspections of the system, and repairing and cleaning it when necessary. The agency responsible for the operation and maintenance should have available the "as-built" data on the drainage works (i.e. as they were built). These include an accurate map of all the main components such as field drains, collectors, connections, and outlet structures (Figure 59).

In addition, the agency should know the elevations of collector points (outlet, inflow and outflow levels in manholes, longitudinal sections), of field drain outlets, and of reference points on major structures like manholes. Most of the required data will be found in the design specifications, but they may need to be updated, because the actual construction may have deviated from the design.

MONITORING

There are three kinds of checks to be made after a drainage system has been installed: a post-construction check, routine checks, and thorough checking.

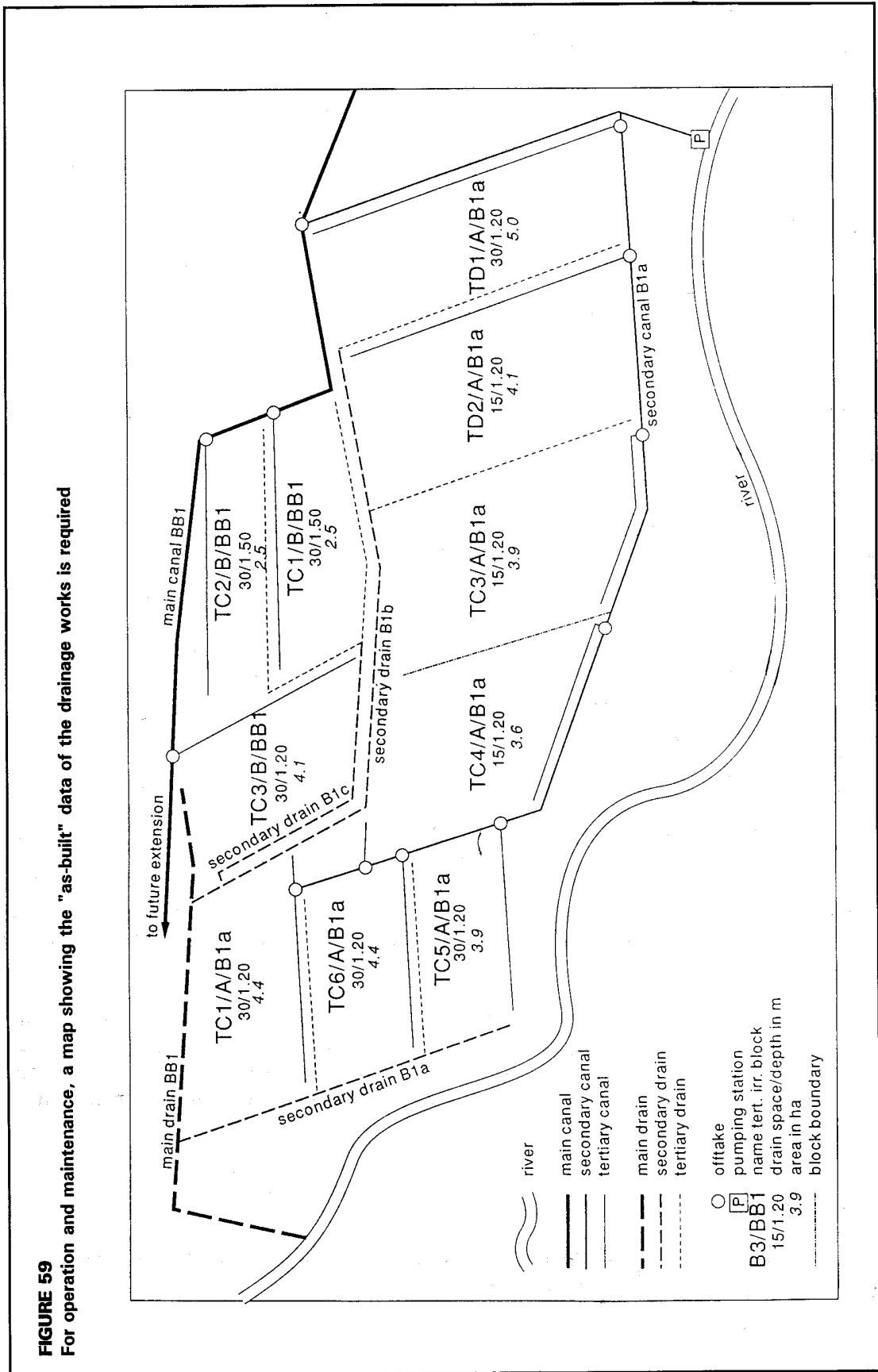

A post-construction check

A post-construction check is done to find out whether the construction was done to an acceptable standard, and whether the drainage works have been delivered in good functional order. This check is mainly covered under the field supervision discussed in Chapter 7.

Routine checks

Routine checks are simple operation-and-maintenance inspections to verify whether the system is functioning properly, and to see whether there is any need for repairs or cleaning. Simple routine inspections can be done according to a locally suitable checklist. Important points to include in such a list are:

- Check the drainage base, which means checking whether the pipe and open drains have free outflow, especially in a period when drainage is most needed. Note, however, that an occasional, very brief submergence of the outlets is normally accepted. A good drainage base is the first and foremost condition for a drainage system to function satisfactorily. If the drainage base is found to be unsatisfactory, the main drainage system should be maintained or improved.
- Check that drains are discharging during and shortly after rain or irrigation (Figure 60).
- Monitor water levels in field and collector drains. High water levels indicate an obstruction in the drain. When high water levels are found, the water levels along a drain should be compared, which may give a clue as to where the problem lies (Figure 61).
- Check whether sediments or other pollutants have accumulated in the drain, structures, or outlets.
- Look at the land surface for wet spots, as signs of waterlogging, a few days after rain or irrigation (Figure 62).
- Check the depth of the water table, especially where wet conditions are found. The water table can be measured in a auger hole or observation well.
- Look for any damage to pipe outlets and structures: a damaged outlet restricts the functioning of a drain.

Note that the observations on drain outflow, water levels, and wet field spots should, of course, concern the same drainage event and the same drain. A suitable time schedule for the above routine inspections would be to start with a first inspection shortly after the system has been installed, during the first or second drainage event when the drains should be running. Further inspections could follow about once a year, a frequency which, after a few years without problems, could possibly be reduced to once every two years. In an irrigation-drainage project, storage of these data in the operating agency's computer data bank is highly recommended.



Thorough checking

A thorough check of the functioning of the system may follow after a routine inspection has revealed significant problems. Such a check may also be intended as a monitoring programme, aimed at improving the design of future drainage projects in the region.

Beside these checks on the physical performance of a drainage system, the effectiveness of the investment in drainage should also be assessed; in other words: "Is the drainage system working as designed?". A monitoring and evaluation (M & E) programme could make such an assessment and could be used to check the criteria used for the design. Monitoring and evaluation should usually be considered from a long-term viewpoint, and should be based on factors that are relatively easy to evaluate. Consideration should be given to the proper collection, storage and retrieval of data. This is of the utmost importance for the subsequent physical and economic analysis of the project.

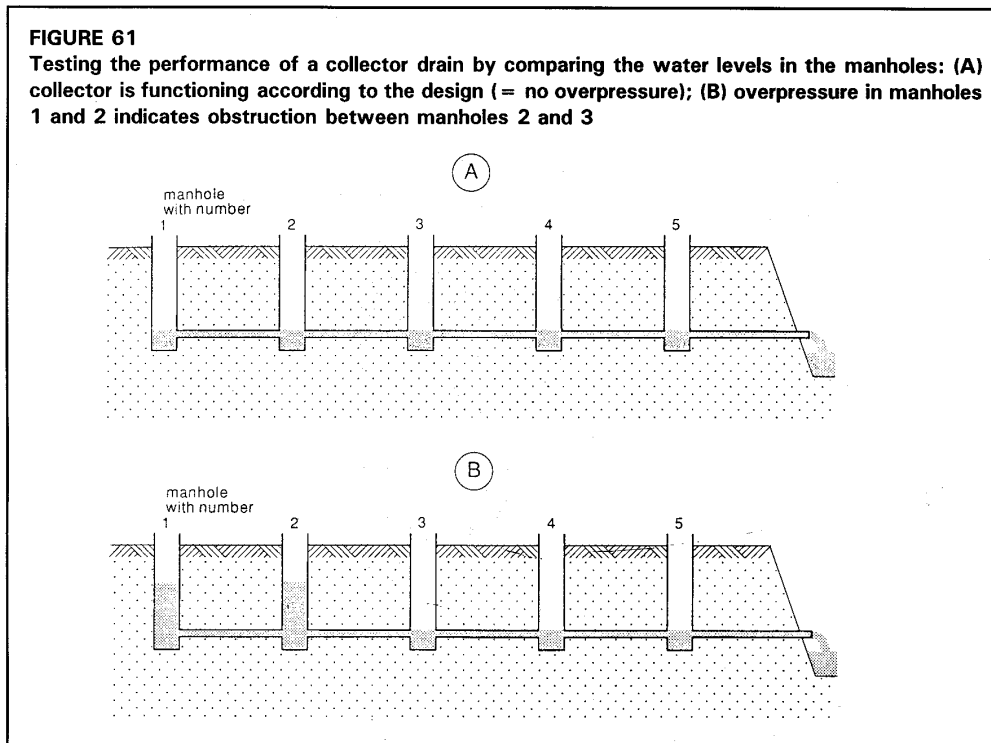

FIGURE 63
In a monitoring and evaluation programme, data on crop yields are collected



In a drainage monitoring programme, the items to be considered are:

- Crop production (Figure 63).
- Drainage water quantity and quality.
- Groundwater quality and level.
- Soil salinity.

FIGURE 64
Maintenance of the land surface by animal traction



MAINTENANCE

Land surface

The benefits derived from land forming will often depend on good maintenance in the subsequent years. A bedding system requires regular maintenance. Care should be taken to eliminate any obstructions to flow or low points in the drains because they will cause standing water and loss of crops. In graded fields, the land should be smoothed each time a field has been ploughed. A small leveller or plane powered by animal traction (Figure 64) or a farm tractor can be used for this purpose.

Open drains

Major problems in maintaining open drains may be due to erosion, settlement, silting, vegetation and seepage. Before the drainage season, drains should be cleaned (e.g. with a shovel or a V-drag); all vegetation should be removed, and side slopes and banks should be repaired when necessary (Figure 65). Siltation should be monitored and removed when required. The frequency depends on the local situation and no hard and fast rules can be given.

Pipe drains

For the maintenance of pipe drains, the problems may be physical blockages, organic and biological blockages, chemical or mineral sealing, and outlet restrictions.

FIGURE 65
Maintenance of open drains should be done before the drainage season

BEFORE MAINTENANCE

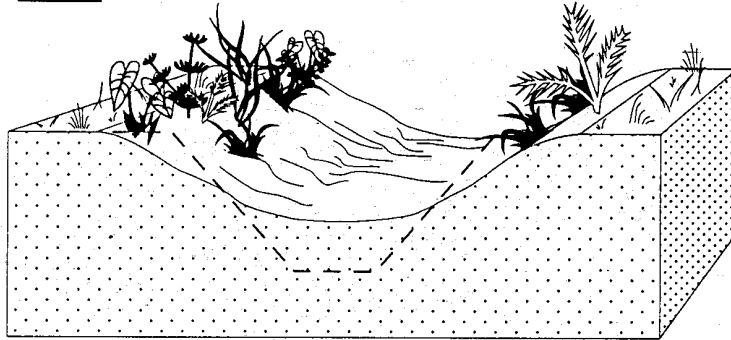

AFTER MAINTENANCE

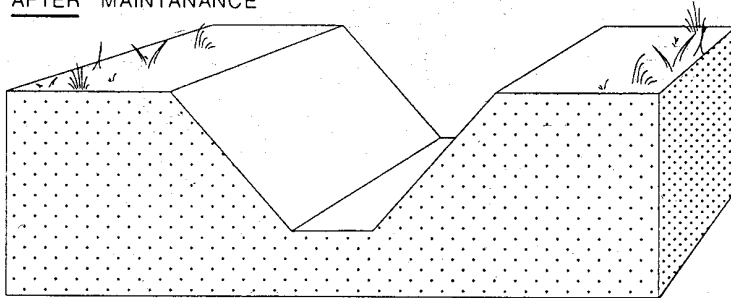

FIGURE 66
Flushing machines are used to clean pipe drains

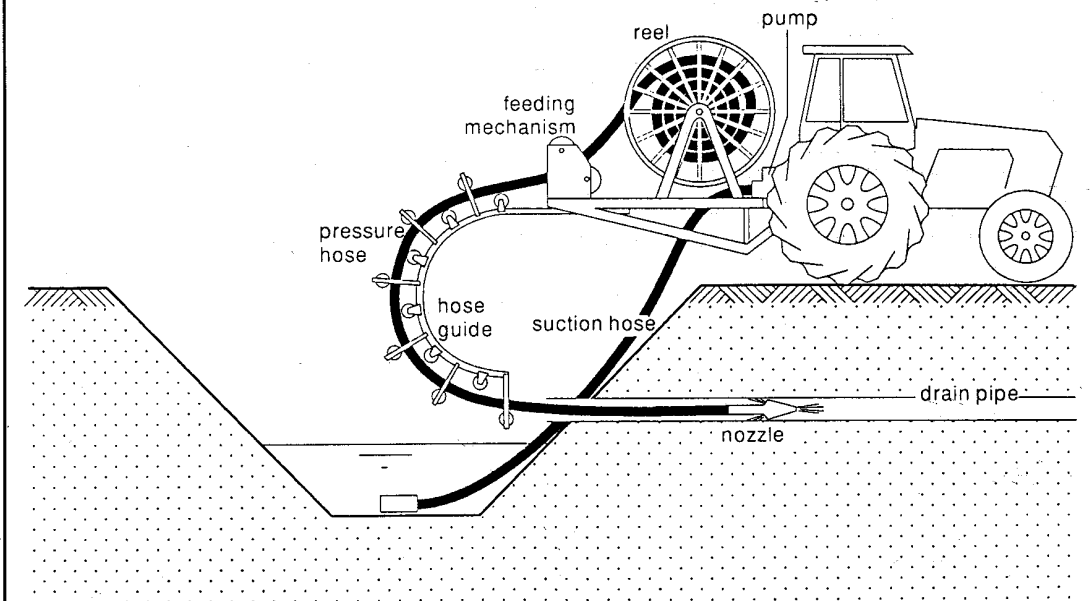

FIGURE 67
Scouring and sedimentation in a drop structure after a high discharge



Before the drainage season, a visual inspection of all outlets should be done, and water levels in manholes should be monitored to check for obstructions or siltation in the pipe sections. Pipe lines can be cleaned with specialized flushing machines which remove sediment from the pipes (Figure 66).

Structures

Structures normally have a higher safety factor than the drains, and in general need less maintenance. Nevertheless, regular and timely inspection is required to identify problems and maintenance needs. This concerns visual inspection as well as regular hydraulic surveys. Moving parts in doors and gates should be checked for wear and tear, and inflow and outflow openings should be cleaned of debris and checked for scouring and damage to banks and the structure itself (Figure 67). In tidal areas and in rivers and drains with high sediment loads, regular flushing and/or dredging might be required.

Without maintenance, a drainage system will not function properly and no sustainable agriculture can be achieved (Figure 68).

FIGURE 68
Good maintenance benefits the farmers



Suggested further reading

- FAO. 1976. Drainage testing. *Irrigation and Drainage Paper 28*. FAO, Rome. 172 pp.
This publication gives guidelines on how to test the functioning and adequacy of single drains and drainage systems.
- FAO. 1970. Drainage materials. *Irrigation and Drainage Paper 9*. FAO, Rome. 122 pp.
This paper discusses the materials used in the construction of pipe drainage systems.
- FAO. 1980. Drainage design factors. *Irrigation and Drainage Paper 38*. 1980. FAO, Rome. 52 pp.
This paper, which is based on an expert consultation, gives 28 questions and answers on drainage design factors.
- FAO. 1983. *Guidelines for the Preparation of Irrigation and Drainage Projects*. Revised Edition. FAO, Rome. 31 pp.
Gives guidelines for a feasibility study, which provides the answers to questions that might be raised in the course of project appraisal.
- Framji, K.K., Garg, B.C. and Kaushish, S.P. 1984. *Design Practices of Open Drainage Channels in an Agricultural Land Drainage System: A Worldwide Survey*. International Commission on Irrigation and Drainage, New Delhi. 343 pp.
This volume consists of two parts. Part I reviews the design of open drainage channels: system layout, design capacity, channel shape, roughness coefficient, permissible channel velocity, longitudinal channel slope, side slope. Part II contains the country reports of Australia, Bangladesh, Canada, Colombia, Czechoslovakia, Egypt, France, Germany, Greece, India, Iraq, Ireland, Japan, Malaysia, Morocco, Portugal, Saudi Arabia, Sudan, UK and the USA.
- Ritzema, H.P. (ed.). 1994. *Drainage Principles and Applications*. Second (completely revised) edition. ILRI, Wageningen. 1994. 1125 pp. ILRI Publication 16.
This completely revised second edition of *Drainage Principles and Applications* is based on lectures delivered at the International Course on Land Drainage, which is held annually by the International Institute for Land Reclamation and Improvement, Wageningen, The Netherlands. The book covers all the various topics useful to those engaged in drainage engineering. Includes a glossary.
Also available is a Spanish version published in 1977, entitled: *Principios y Aplicaciones del Drenaje* (in four volumes).
- Schultz, B. 1990. *Guidelines on the Construction of Horizontal Subsurface Drainage Systems*. International Commission on Irrigation and Drainage, New Delhi. 236 pp.
This book starts with an inventory of subsurface drainage systems and then briefly reviews their design. It discusses drainage materials and equipment to install the drains.

It then recommends construction methods, and advises on operation and maintenance. Finally, it treats the cost-benefit analysis of projects. Includes a glossary.

Smedema, L.K. and Rycroft, D. 1983. *Land Drainage : Planning and Design of Agricultural Drainage Systems*. Batsford, London, UK. 376 pp.

This book discusses the diagnosis of agricultural drainage problems and their solutions, based on an understanding of the physical principles involved. Land drainage is treated as being a field of applied soil physics and applied hydrology. All major drainage problems are covered, each in its particular environment and field of application: Groundwater Drainage; Water Table Control; Surface Drainage of Sloping and Flat Lands; Shallow Drainage of Heavy Land; Drainage for Salinity Control in Irrigated Land; Drainage and Reclamation of Polders; Drainage for Seepage Control; Main Drainage: Design Discharges, Canal Design, Outlets.

The book stresses the universal relationships between the main design variables and soil, climatology, and other relevant environmental conditions.